

Dixi

Medium Low Pressure Gas Regulator

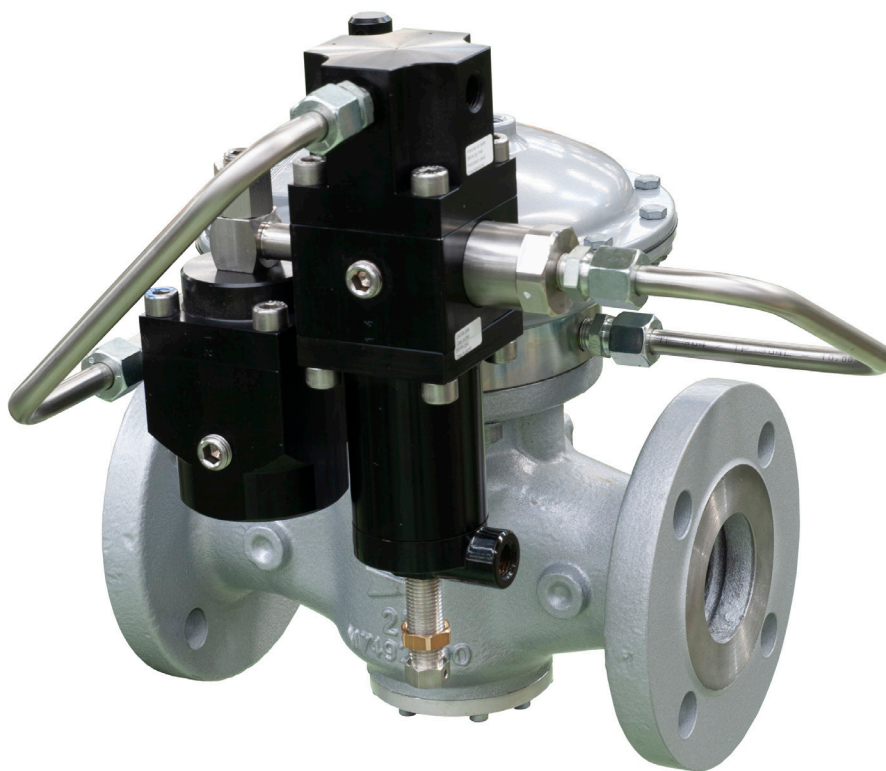

TECHNICAL BROCHURE

Pietro Fiorentini S.p.A.

Via E.Fermi, 8/10 | 36057 Arcugnano, Italy | +39 0444 968 511
sales@fiorentini.com

The data are not binding. We reserve the right
to make changes without prior notice.

dixi_technicalbrochure_ENG_revA

www.fiorentini.com

Who we are

We are a global organization specialized in designing and manufacturing technologically advanced solutions for natural gas treatment, transmission and distribution systems.

We are the ideal partner for operators in the Oil & Gas sector, with a business offer that goes across the whole natural gas chain.

We are in constant evolution to meet our customers' highest expectations in terms of quality and reliability.

Our aim is to be a step ahead of the competition, with customized technologies and an after-sale service program undertaken with the highest grade of professionalism.



Pietro Fiorentini advantages



Localised technical support



Experience since 1940



We operate in over 100 countries

Area of Application

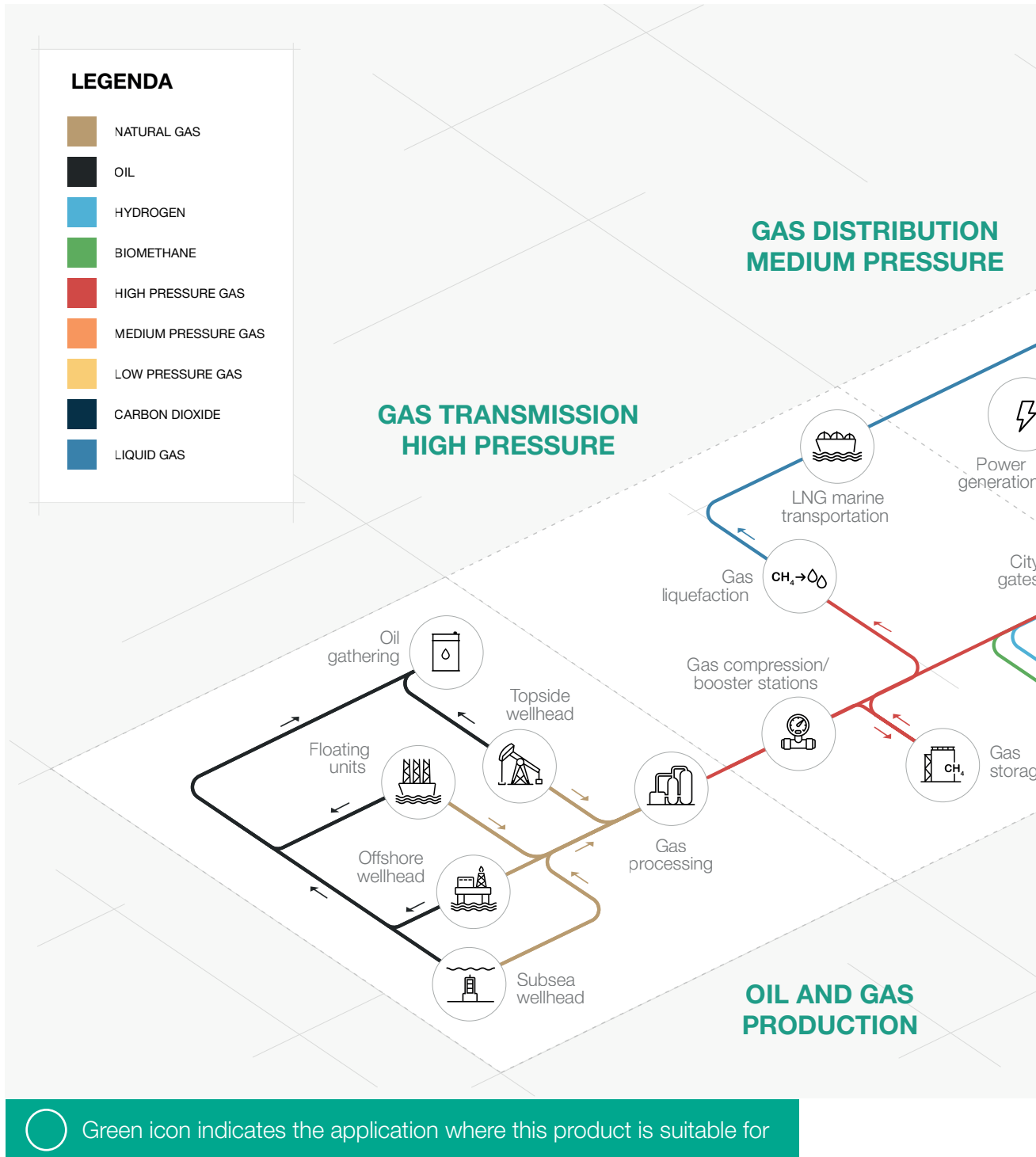

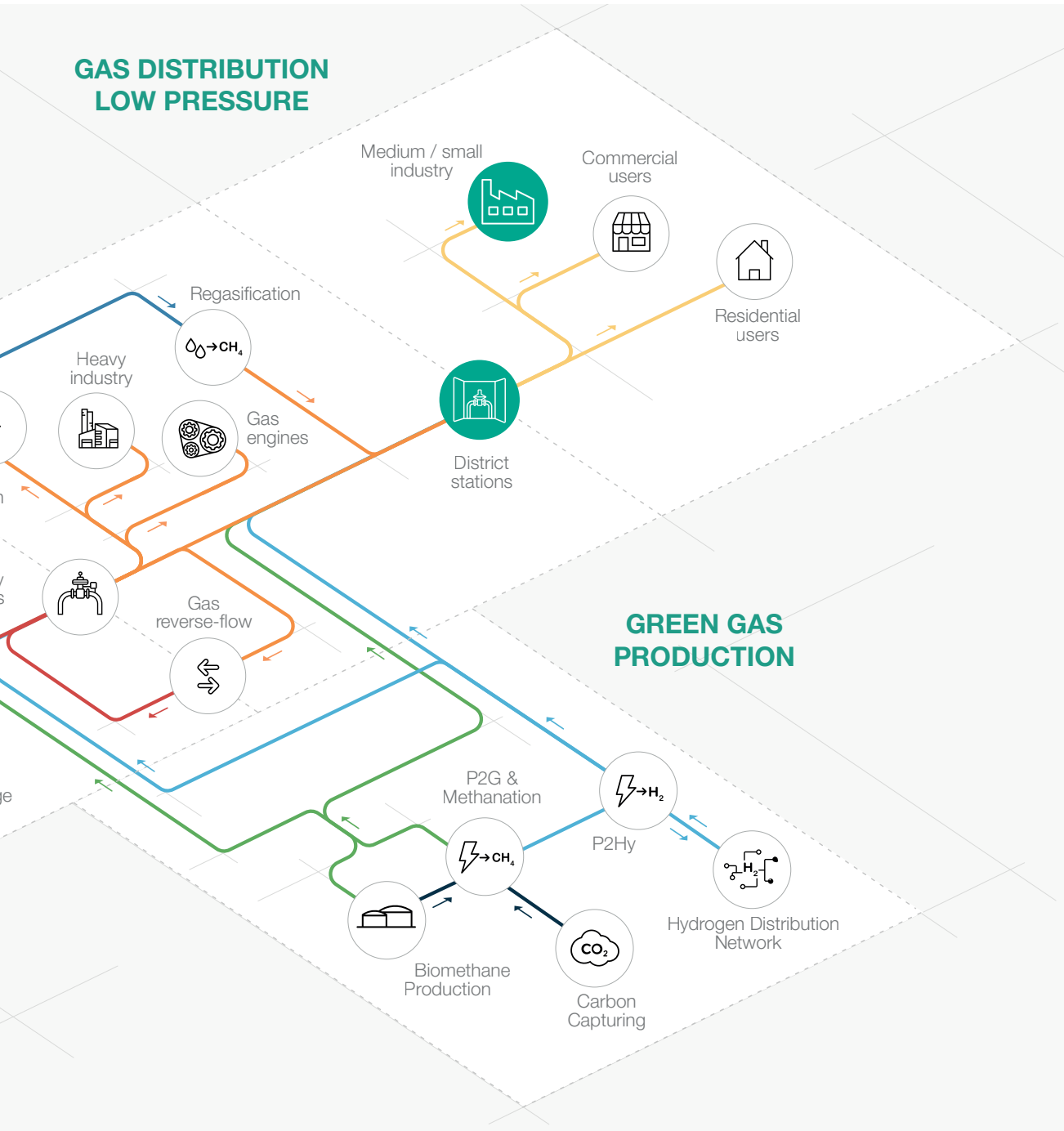

Figure 1 Area of Application Map



Introduction

Dixi is one of the **pilot-operating gas pressure regulators** designed and manufactured by Pietro Fiorentini.

This device is suitable for use with previously filtered non-corrosive gases, and it is mainly used for medium and low pressure natural gas distribution networks.

According to the European Standard EN 334, it is classified as **Fail Close**.

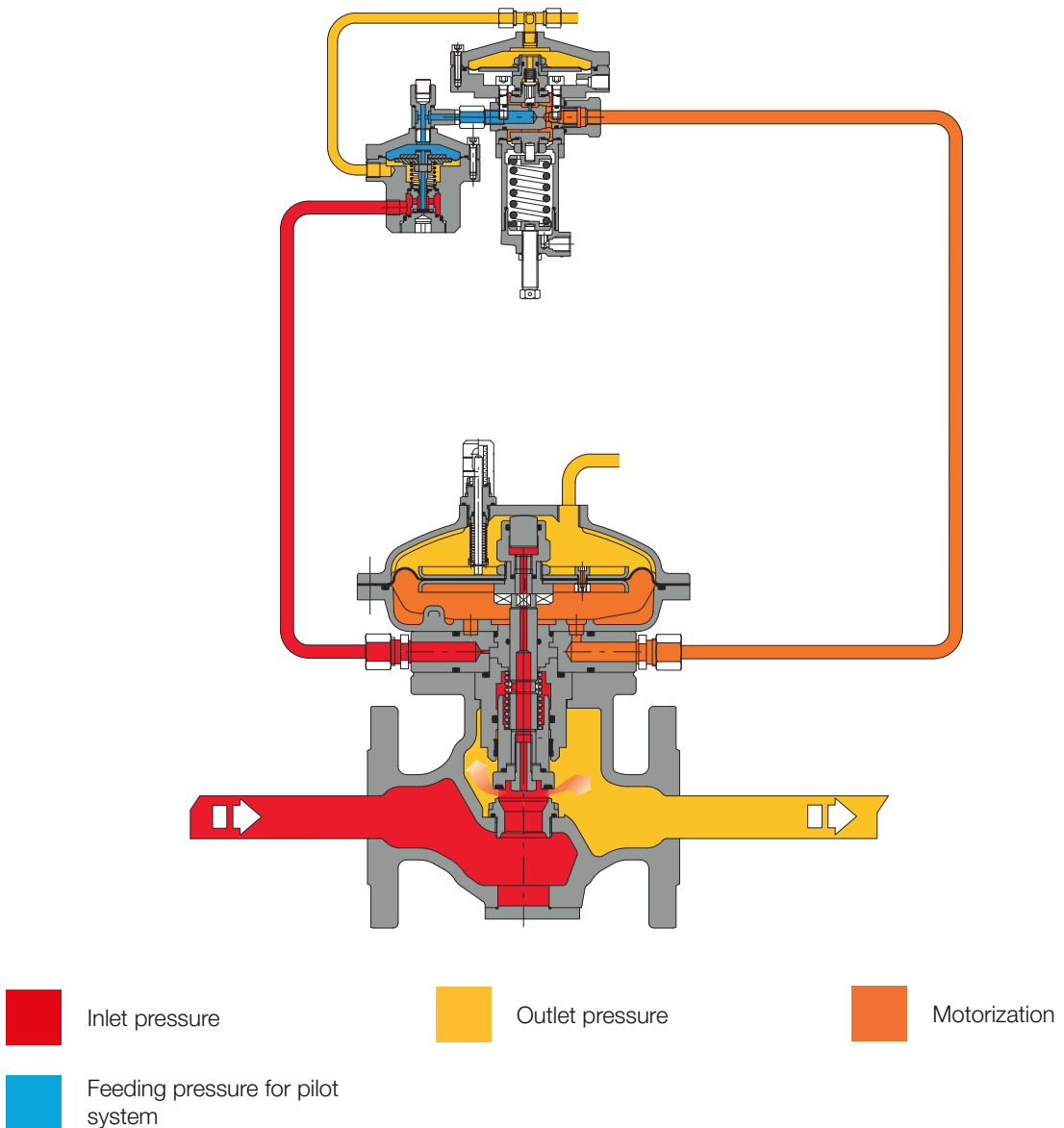

Figure 2 Dixi

Features and Calibration ranges

The **Dixi** is a **pilot-operated** device for medium pressure and low pressure with a unique **dynamic balancing system** which ensures an **outstanding turn down ratio** combined with an extremely **accurate outlet pressure control**.

A balanced pressure regulator it is a pressure regulator where delivery pressure accuracy it is not affected by the fluctuation of the inlet pressure and flow during its operation. Therefore, a balance pressure regulator can have a single orifice for all pressure and flow operating conditions.

This regulator is suitable for use with previously filtered, non corrosive gases and distribution networks as well as high load industrial applications.

It is a **truly top entry design** which allows an **easy maintenance** of parts directly in the field **without removing the body from the pipework**.

Set point adjustment of the regulator is operated via a pilot unit used to load and unload the bleeding pressure from the top chamber.

The modular design of Dixi pressure regulators allows LA slam shut valve.

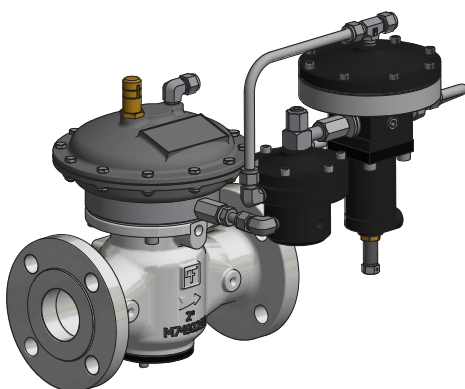

Figure 3 Dixi

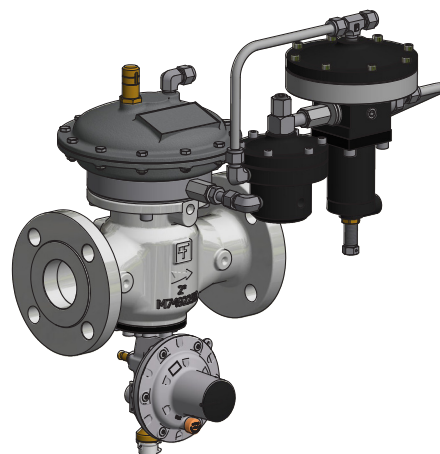

Figure 4 Dixi with LA slam shut valve



Dixi competitive advantages



Compact and simple design



Top Entry



High accuracy



Easy maintenance



1:500 High turn-down ratio



In-build accessories



Fail Close plug and seat regulator



Balanced type



Built-in pilot filter



Biomethane compatible and 10% Hydrogen blending compatible. Higher blending available on request

Features

Features	Values
Design pressure*	up to 1.6 MPa up to 16 barg
Ambient temperature*	from -20 °C to +60 °C from -4 °F to +140 °F
Inlet gas temperature range*	from -20 °C to +60 °C from -4 °F to +140 °F
Inlet pressure range bpu (MAOP)	from 0.05 to 1.6 MPa from 0.5 to 16 barg
Range of downstream pressure Wd	from 0.0007 to 0.6 MPa from 0.007 to 6 barg
Available Accessories	LA Slam shut, opening indicator
Minimum differential pressure	0.01 MPa 0.1 barg
Accuracy class AC	up to 2.5
Lock-up pressure class SG	up to 10
Nominal dimensions DN	DN 25 / 1"; DN 40 / 1" 1/2; DN 50 / 2";
Connections*	Class 150 RF according to ASME B16.5 and PN16, 25 according to ISO 7005

(*) REMARK: Different functional features and/or extended temperature ranges available on request. Stated temperature ranges are the maximum for which the equipment's full performance, including accuracy, are fulfilled. Standard product may have a narrower range.

Table 1 Features

Materials and Approvals

Part	Material
Body	Cast steel ASTM A216 WCB for all sizes Ductile cast iron GS 400-18 ISO 1083
Heads	Die cast aluminium EN AC 43500
Seat	Stainless steel
Diaphragm	Rubberized canvas
O-rings	Nitrile Rubber
Compression fittings	According to DIN 2353 in zinc-plated carbon steel. Stainless steel on request

REMARK: The materials indicated above refer to the standard models. Different materials can be provided according to specific needs.

Table 2 Materials

Construction Standards and Approvals

Dixi regulator is designed according to the European standard EN 334.
The regulator reacts in closing (Fail Close) according to EN 334.

The product is certified according to European Directive 2014/68/EU (PED).
Leakage class: bubble tight, better than VIII according to ANSI/FCI 70-3.



EN 334



PED-CE



Pilot ranges and types

Type	Model	Operation	Range Wh		Spring Table web link
			KPa	mbarg	
Main pilot	201/A	Manual	0.7 - 58	7 - 580	TT 475

Table 3 Settings table

Pilot adjustment	
Pilot type .../A	Manual setting
Pilot type .../D	Electric remote setting control
Pilot type .../CS	Pneumatic remote setting control
Pilot type .../FIO	Smart unit for remote setting, monitoring, flow limitation

Table 4 Pilot adjustment table

General link to the calibration tables: [PRESS HERE](#) or use the QR code:



Accessories

For the pressure regulators:

- Cg limiter
- Limit switches
- Position transmitter
- Slam shut valve

For the pilot circuit:

- Supplementary filter CF14 or CF14/D

In-line Monitor

The in-line monitor is generally installed upstream of the active regulator.

Although the function of the monitor regulator is different, the two regulators are virtually identical from the point of view of their mechanical components.

The only difference is that monitor is set at a higher pressure than active regulator.

The Cg coefficients of the worker regulator with an in-line monitor is the same, but during worker regulator sizing it shall be considered the differential pressure drop generated by the fully open in-line monitor. As a practice, to incorporate this effect a Cg reduction of 20% of the worker regulator can be applied.

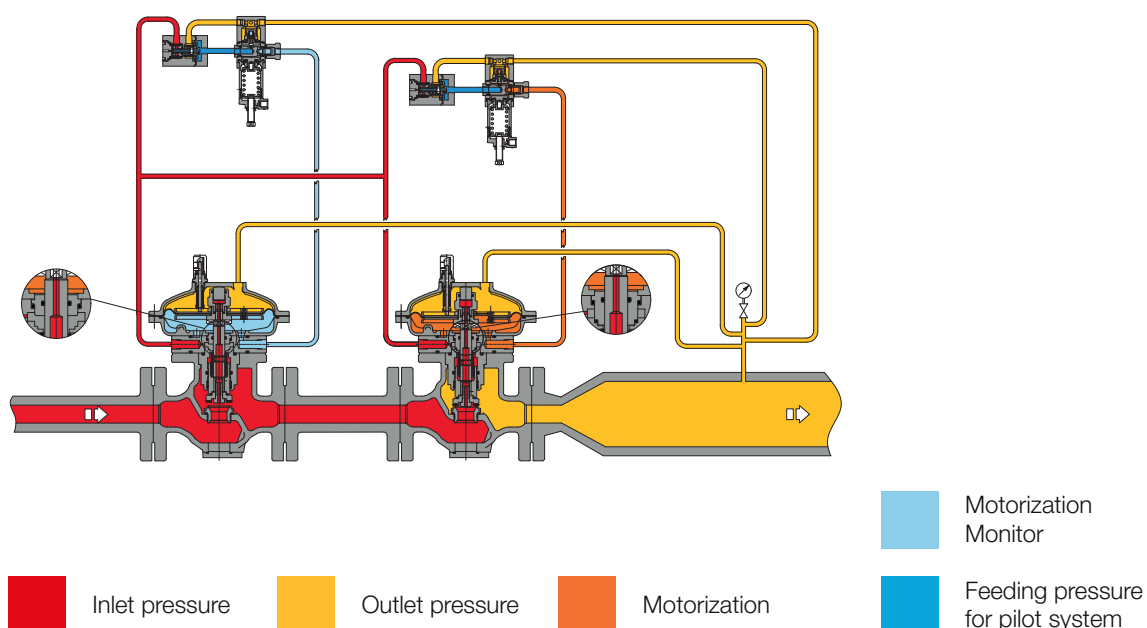

Figure 5 Dixi in-line monitor



Slam Shut LA









The dixi pressure regulator offers the possibility of installing an **incorporated slam shut valve LA** and this can be done either during the manufacturing process or be retrofitted in the field.

LA is available for all sizes.

Retrofitting can be done without modifying the pressure regulator assembly.

With the built-in slam shut, the Cg valve coefficients is 5% lower than the corresponding version without.

The main characteristics of this device are:

-  Over Pressure Shut-Off
-  Under Pressure Shut-Off
-  Internal by-pass
-  Push button for tripping test
-  Compact dimensions
-  Easy maintenance
-  Remote tripping option
-  Limit switch option

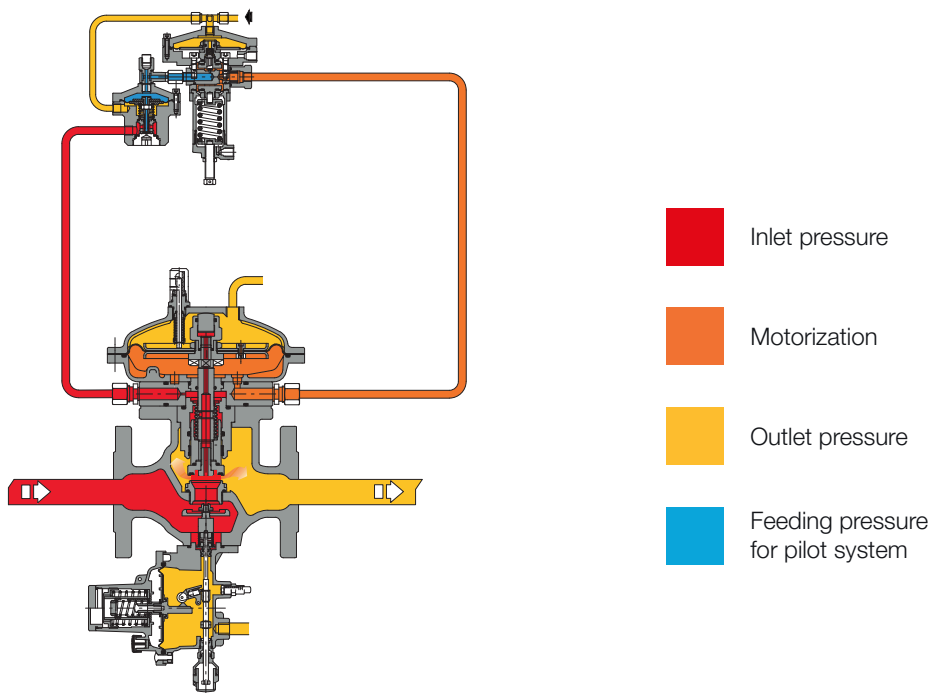

Figure 6 Dixi with LA

Pressure switch types and ranges					
SSV Type	Model	Operation	Range Wh		Spring Table web link
			KPa	mbarg	
LA	BP	OPSO	3 - 18	30 - 180	TT 00214
		UPSO	0.6 - 6	6 - 60	
LA	MP	OPSO	14 - 45	140 - 450	TT 00214
		UPSO	1 - 24	10 - 240	
LA	TR	OPSO	25 - 550	250 - 5500	TT 00214
		UPSO	10 - 350	100 - 3500	

Table 5 Settings table



Weights and Dimensions

Dixi

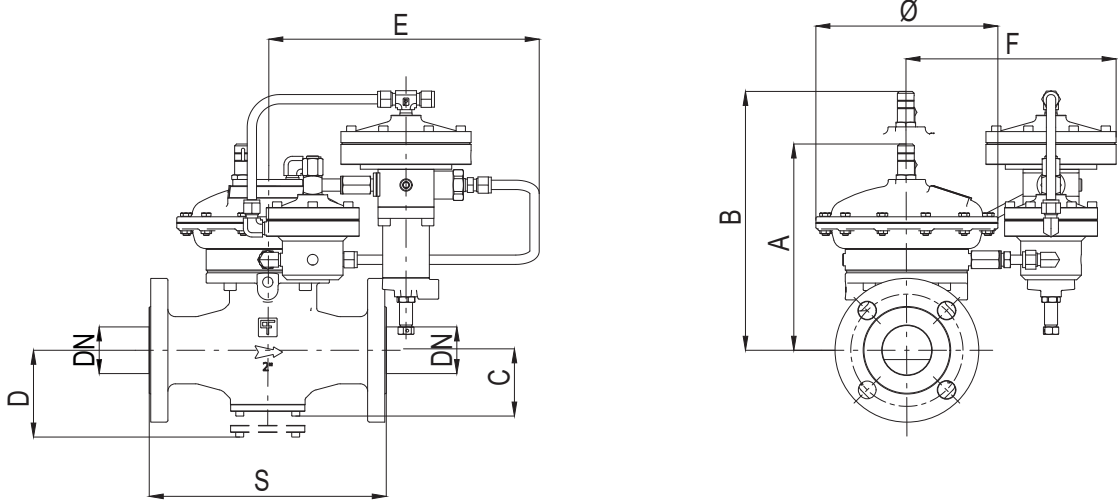

Figure 7 Dixi dimensions

Weights and Dimensions (for other connections please contact your closest Pietro Fiorentini representative)

	[mm] inches	[mm] inches	[mm] inches	[mm] inches
Size (DN)	25 1"	40 1" 1/2	50 2"	50 2"
Type	flanged	flanged	threaded	flanged
S - Ansi 150/PN 16	183 7.2"	223 8.78"	220 8.66"	254 10"
Ø	200 7.87"	200 7.87"	200 7.87"	200 7.87"
A	230 9.06"	240 9.45"	240 9.45"	240 9.45"
B	260 10.24"	270 10.63"	270 10.63"	270 10.63"
C	80 3.15"	90 3.54"	90 3.54"	90 3.54"
D	100 3.94"	100 3.94"	100 3.94"	100 3.94"
E	290 11.42"	290 11.42"	290 11.42"	290 11.42"
F	210 8.27"	210 8.27"	210 8.27"	210 8.27"
Tubing Connections	Øe 10 x Øi 8 (on request imperial sizing)			

Weight	Kg lbs	Kg lbs	Kg lbs	Kg lbs
ANSI150/PN 16	12 26	15 33	16 35	21 46

Table 6 Weights and dimensions

Dixi + LA

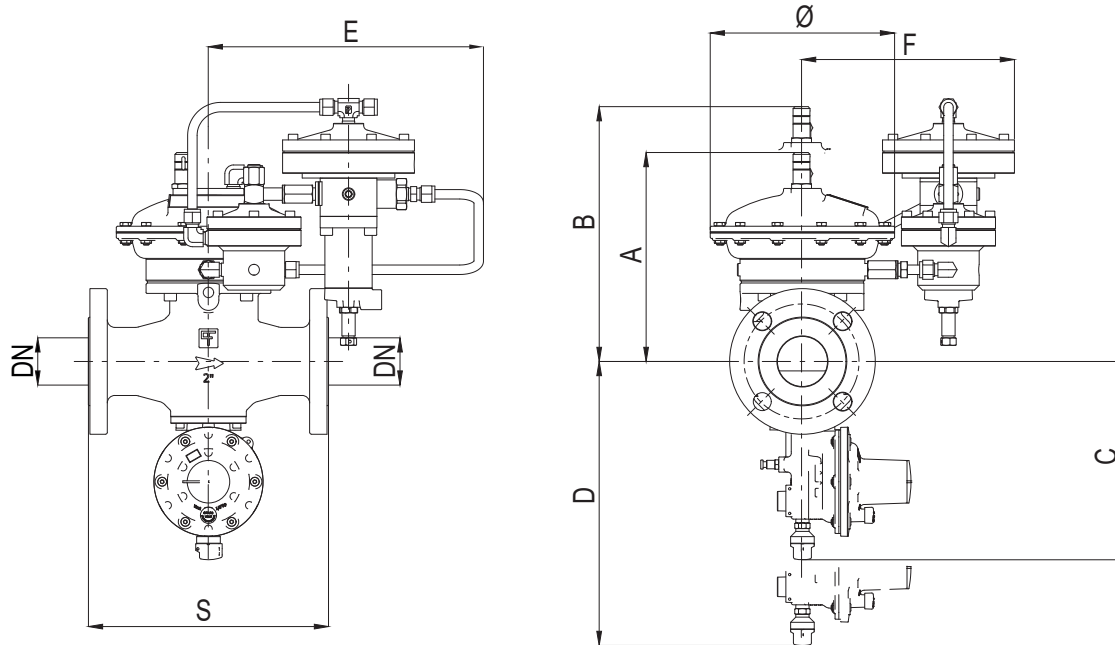

Figure 8 Dixi + LA dimensions

Weights and Dimensions (for other connections please contact your closest Pietro Fiorentini representative)

	[mm] inches	[mm] inches	[mm] inches	[mm] inches
Size (DN)	25 1"	40 1 1/2"	50 2"	50 2"
Type	flanged	flanged	threaded	flanged
S - Ansi 150/PN 16	183 7.2"	223 8.78"	220 8.66"	254 10"
Ø	200 7.87"	200 7.87"	200 7.87"	200 7.87"
A	230 9.06"	240 9.45"	240 9.45"	240 9.45"
B	260 10.24"	270 10.63"	270 10.63"	270 10.63"
C	200 7.87"	200 7.87"	200 7.87"	200 7.87"
D	220 8.66"	220 8.66"	220 8.66"	220 8.66"
E	290 11.42"	290 11.42"	290 11.42"	290 11.42"
F	210 8.27"	210 8.27"	210 8.27"	210 8.27"
Tubing Connections	Øe 10 x Øi 8 (on request imperial sizing)			

Weight	Kg lbs	Kg lbs	Kg lbs	Kg lbs
ANSI150/PN 16	13 29	16 35	17 37	22 49

Table 7 Weights and dimensions



Sizing and Cg

In general, the choice of a regulator is made based on the calculation of the flow rate determined by the use of formulae using the flow rate coefficients (Cg) and the form factor (K1) as indicated by the EN 334 standard.

Flow rate coefficient			
Nominal size	25	40	50
Inches	1"	1" 1/2	2"
Cg	540	983	1014
K1	104	96	96

Table 8 Flow rate coefficient

For sizing [PRESS HERE](#) or use the QR code:



Note: In case you do not have the proper credentials to access, feel free to contact your closest Pietro Fiorentini representative.

In general the online sizing considers multiple variables as the regulator is installed in a system, enabling a better and multiperspective approach to the sizing.

For different gases, and for natural gas with a different relative density other than 0.61 (compared to air), the correction coefficients from the following formula shall be applied.

$$F_c = \sqrt{\frac{175,8}{S \times (273,16 + T)}}$$

S = relative density (refere to table 9)
T = gas temperature (°C)

Correction Factor Fc		
Gas Type	Relative Density S	Correction Factor Fc
Air	1.00	0.78
Propane	1.53	0.63
Butane	2.00	0.55
Nitrogen	0.97	0.79
Oxygen	1.14	0.73
Carbon Dioxide	1.52	0.63

Note: the table shows the Fc correction factors valid for Gas, calculated at a temperature of 15°C and at the declared relative density.

Table 9 Correction Factor Fc

Flow rate conversion
$\text{Stm}^3/\text{h} \times 0.94795 = \text{Nm}^3/\text{h}$

Nm^3/h reference conditions T= 0 °C; P= 1 barg
 Stm^3/h reference conditions T= 15 °C; P= 1 barg

Table 10 Flow rate conversion

CAUTION:

In order to get optimal performance, to avoid premature erosion phenomena and to limit noise emissions, it is recommended to check that the gas speed at the outlet flange does not exceed the values of the graph below. The gas speed at the outlet flange may be calculated by means of the following formula:

$$V = 345.92 \times \frac{Q}{\text{DN}^2} \times \frac{1 - 0.002 \times \text{Pd}}{1 + \text{Pd}}$$

V = gas speed in m/s
 Q = gas flow rate in Stm^3/h
 DN = nominal size of regular in mm
 Pd = outlet pressure in barg

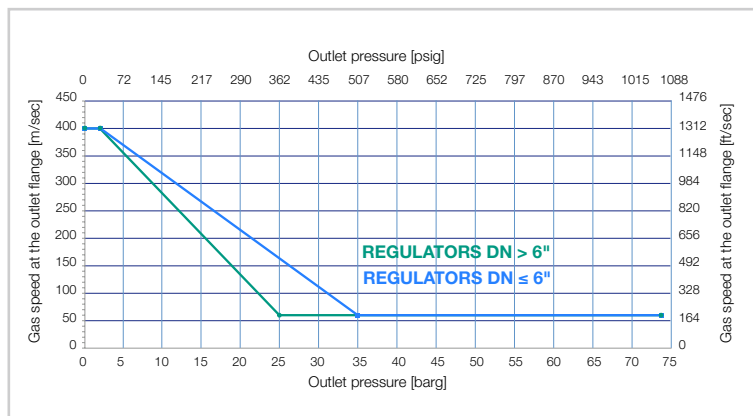



Sizing of regulators is usually made based on valve Cg value (table 8).

Flow rates at fully open position and various operating conditions are related by the following formulae where:

Q = flow rate in Stm³/h

Pu = inlet pressure in bar (abs)

Pd = outlet pressure in bar (abs).

- **A** > when the Cg value of the regulator is known, as well as Pu and Pd, the flow rate can be calculated as follows:

- **A-1** in sub critical conditions: (Pu < 2 x Pd)

$$Q = 0.526 \times C_g \times P_u \times \sin \left(K_1 \times \sqrt{\frac{P_u - P_d}{P_u}} \right)$$

- **A-2** in critical conditions: (Pu ≥ 2 x Pd)

$$Q = 0.526 \times C_g \times P_u$$

- **B** > vice versa, when the values of Pu, Pd and Q are known, the Cg value, and hence the regulator size, may be calculated using:

- **B-1** in sub-critical conditions: (Pu < 2 x Pd)

$$C_g = \frac{Q}{0.526 \times P_u \times \sin \left(K_1 \times \sqrt{\frac{P_u - P_d}{P_u}} \right)}$$

- **B-2** in critical conditions (Pu ≥ 2 x Pd)

$$C_g = \frac{Q}{0.526 \times P_u}$$

NOTE: The sin value is understood to be DEG.



**Pietro
Fiorentini**



Pietro Fiorentini

TB0019ENG



The data are not binding. We reserve the right
to make changes without prior notice.

[dixi_technicalbrochure_ENG_revA](#)

www.fiorentini.com