

# Terval/R

Medium Low Pressure Gas Regulator

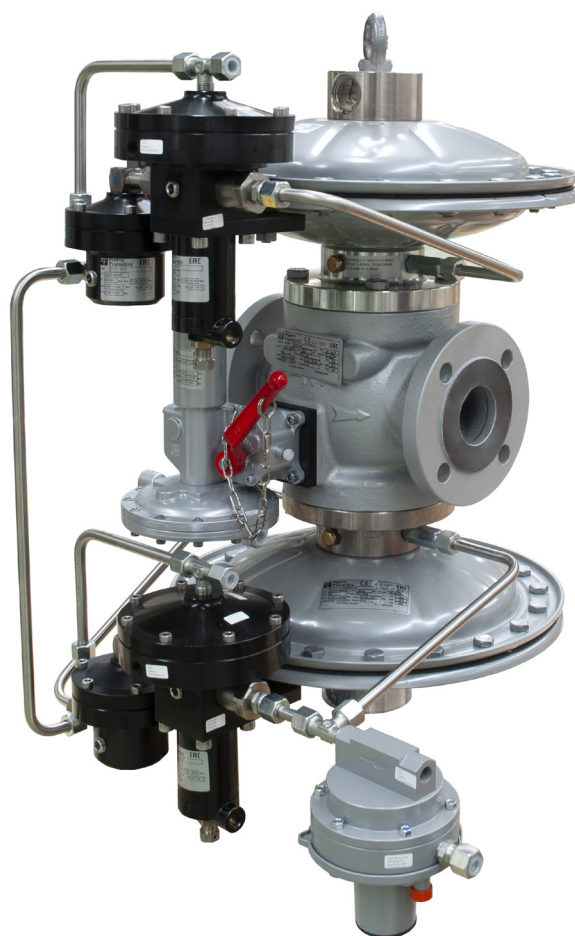

**TECHNICAL BROCHURE**

**Pietro Fiorentini S.p.A.**

Via E.Fermi, 8/10 | 36057 Arcugnano, Italy | +39 0444 968 511  
sales@fiorentini.com

The data are not binding. We reserve the right  
to make changes without prior notice.

tervalr\_technicalbrochure\_ENG\_revC

**[www.fiorentini.com](http://www.fiorentini.com)**

# Who we are

We are a global organization specialized in designing and manufacturing technologically advanced solutions for natural gas treatment, transmission and distribution systems.

We are the ideal partner for operators in the Oil & Gas sector, with a business offer that goes across the whole natural gas chain.

We are in constant evolution to meet our customers' highest expectations in terms of quality and reliability.

Our aim is to be a step ahead of the competition, with customized technologies and an after-sale service program undertaken with the highest grade of professionalism.



## Pietro Fiorentini advantages



Localised technical support



Experience since 1940



We operate in over 100 countries

# Area of Application

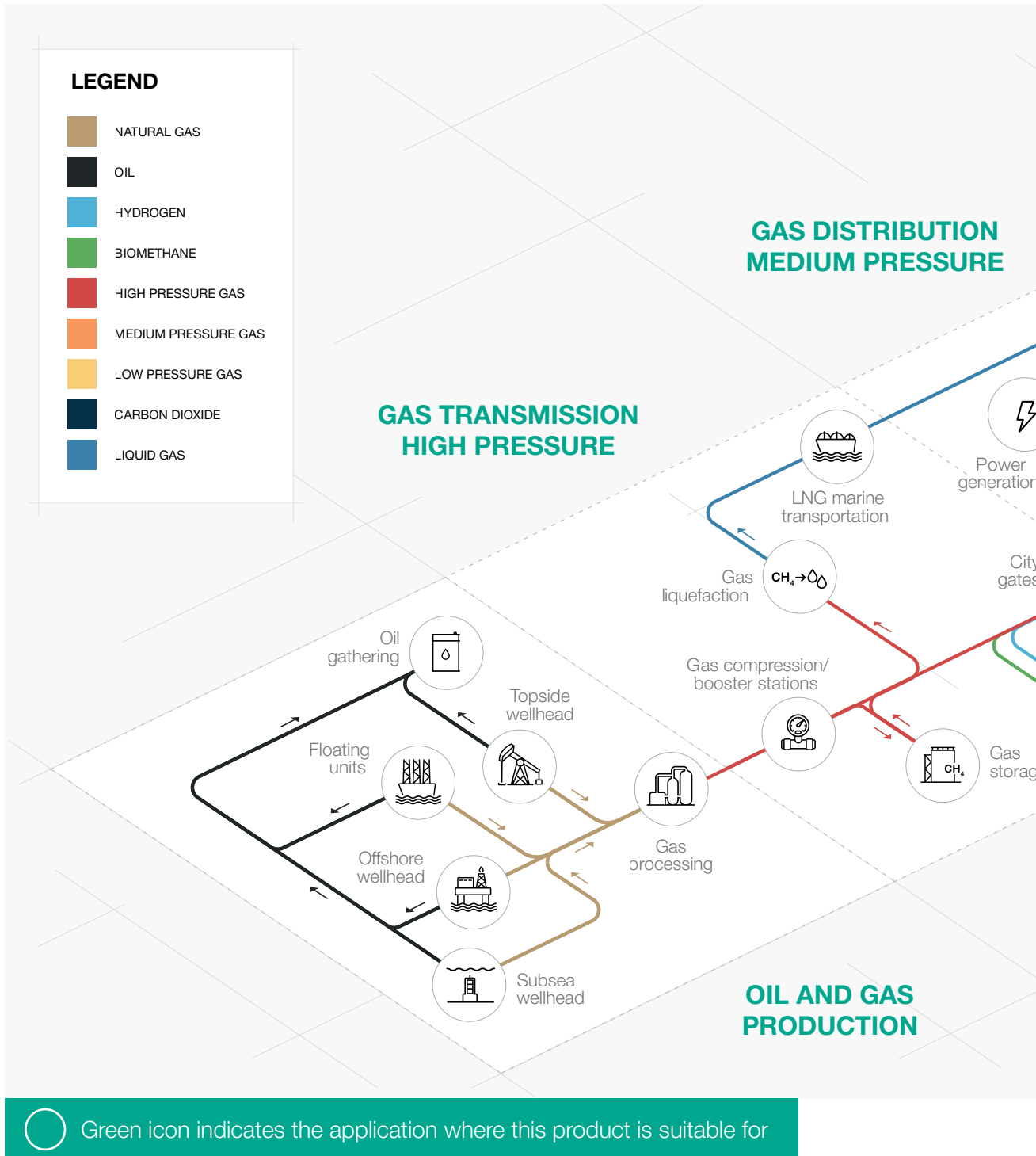

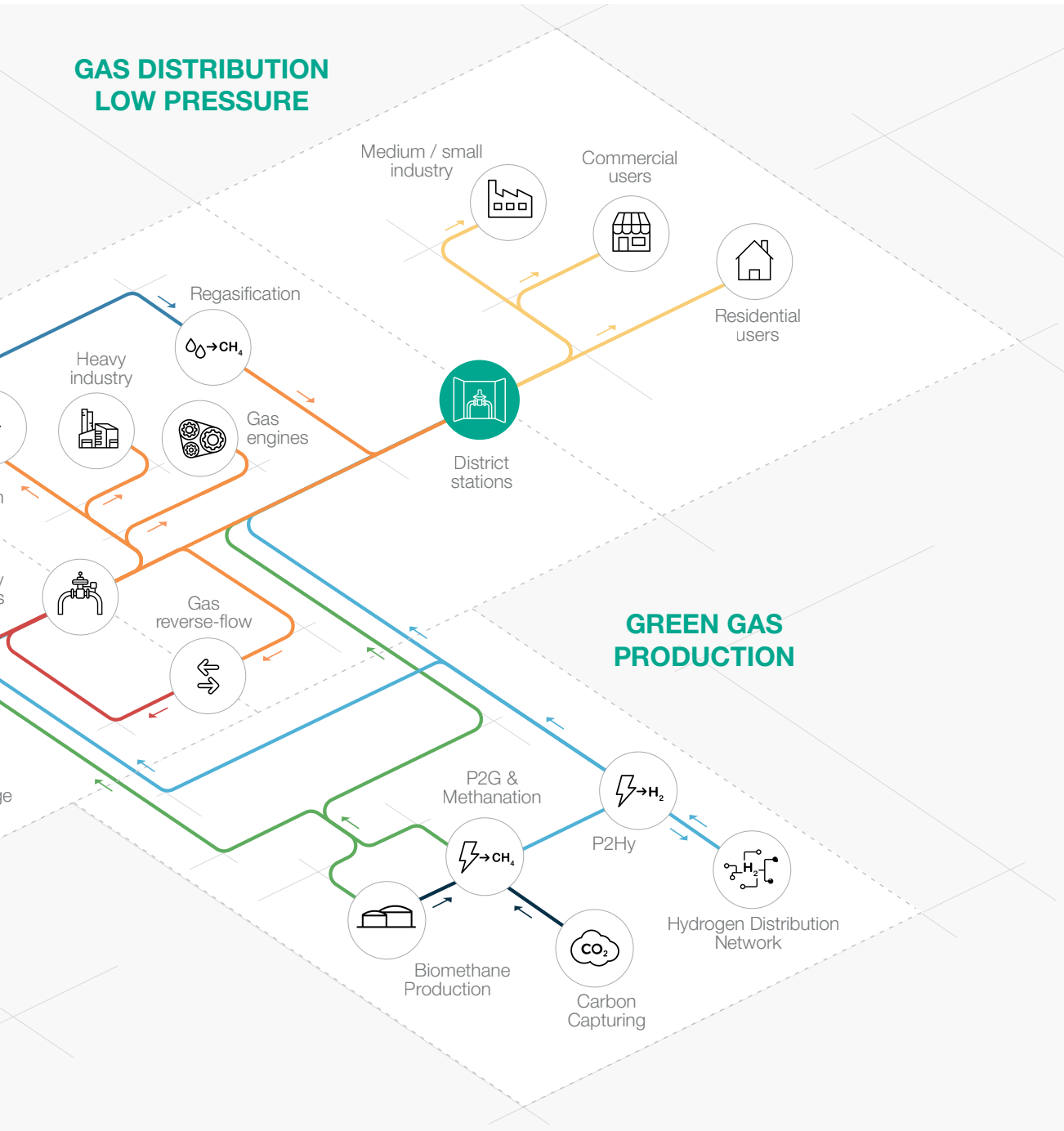

**Figure 1** Area of Application Map



# Introduction

**Terval/R** is one of the **pilot-operated gas pressure regulators** designed and manufactured by Pietro Fiorentini.

This device is suitable for use with previously filtered non-corrosive gases, and it is mainly used for medium and low pressure natural gas distribution networks.

According to the European Standard EN 334, it is classified as **Fail Close**.

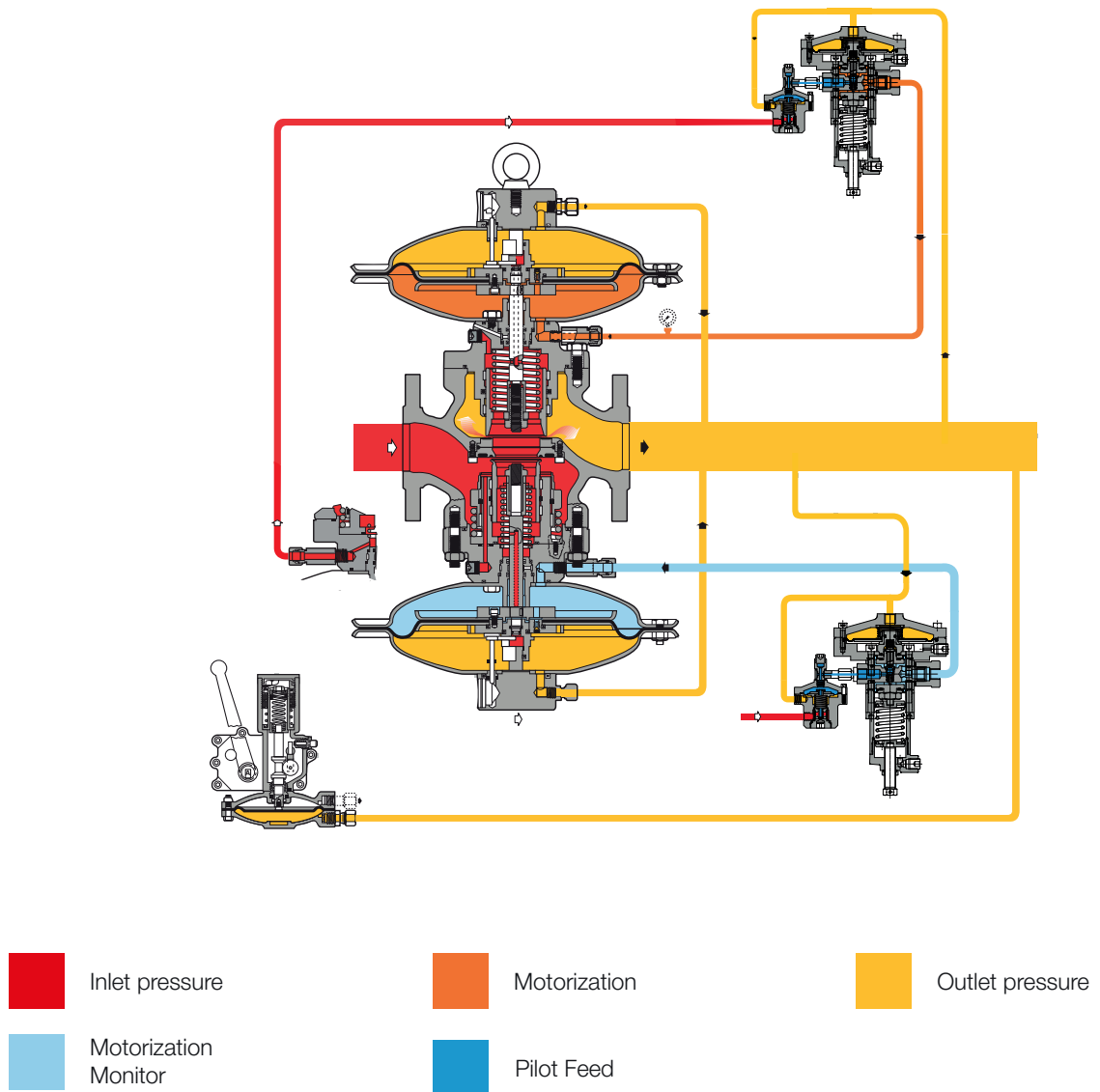

**Figure 2** Terval/R

# Features and Calibration ranges

Terval/R is a **pilot-operated** device for medium pressure and low pressure with a unique **dynamic balancing system** which ensures an **outstanding turn down ratio** combined with an extremely **accurate outlet pressure control**.

A balanced pressure regulator it is a pressure regulator where delivery pressure accuracy it is not affected by the fluctuation of the inlet pressure and flow during its operation. Therefore, a balance pressure regulator can have a single orifice for all pressure and flow operating conditions.

This regulator is suitable for use with previously filtered, non corrosive gases and distribution networks as well as high load industrial applications.

It is a **truly top entry design** which allows an **easy maintenance** of parts directly in the field **without removing the body from the pipework**.

Set point adjustment of the regulator is operated via a pilot unit used to load and unload the bleeding pressure from the top chamber.

The modular design of Terval/R pressure regulators allows to have both emergency monitor PM/182 and slam shut SA simultaneously on the same body.

Futhermore it can be equipped with silencer DB/93 model on the same body too.

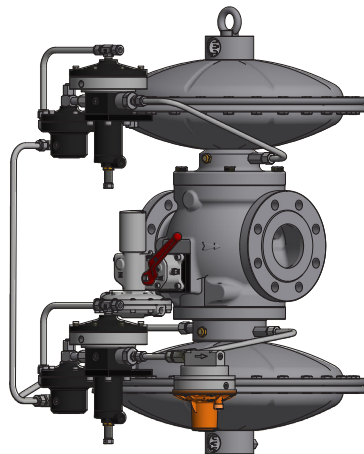



**Figure 3** Terval/R





## Terval/R competitive advantages

- 

Balanced type
- 

Top Entry
- 

Operate with low differential pressure
- 

Easy maintenance
- 

High accuracy
- 

Low noise
- 

3 functions in 1 body
- 

Built-in accessories
- 

Built-in pilot filter
- 

Biomethane compatible and 10% Hydrogen blending compatible. Higher blending available on request

## Features

Features	Values
Design pressure*	up to 2.5 MPa up to 25 barg
Ambient temperature*	from -20 °C to +60 °C from -4 °F to +140 °F
Inlet gas temperature range*	from -20 °C to +60 °C from -4 °F to +140 °F
Inlet pressure range bpu (MAOP)	from 0.05 to 2.5 MPa from 0.5 to 25 barg
Range of downstream pressure Wd	from 0.0008 to 1.2 MPa from 0.008 to 12 barg
Available Accessories	DB/182 Silencer
Minimum differential pressure	0.01 MPa 0.1 barg
Accuracy class AC	up to 2.5
Lock-up pressure class SG	up to 5
Nominal dimensions DN	DN 50 / 2" DN 65 / 2" 1/2; DN 80 / 3"; DN 100 / 4"
Connections*	Class 150 RF or RTJ according to ASME B 16.5 and PN 25 and 40 according to ISO 7005

**(\*) REMARK: Different functional features and/or extended temperature ranges available on request. Stated temperature ranges are the maximum for which the equipment's full performance, including accuracy, are fulfilled. Standard product may have a narrower range.**

**Table 1** Features



# Materials and Approvals

Part	Material
Body	Cast steel ASTM A216 WCB for all sizes Ductile iron GS 400-18 ISO 1083 for Size ≤ 8"
Heads	Die stamped carbon steel
Stem	AISI 416 stainless steel
Plug	ASTM A 350 LF2 nickel coated on sealing surfaces
Seat	Steel + vulcanized rubber
Diaphragm	Rubberized canvas
O-rings	Nitrile Rubber
Compression fittings	According to DIN 2353 in zinc-plated carbon steel

**REMARK: The materials indicated above refer to the standard models. Different materials can be provided according to specific needs.**

**Table 2** Materials

## Construction Standards and Approvals

**Terval/R** regulator is designed according to the European standard EN 334. The regulator reacts in closing (Fail Close) according to EN 334.

The product is certified according to European Directive 2014/68/EU (PED). Leakage class: bubble tight, better than VIII according to ANSI/FCI 70-3.



EN 334



PED-CE



# Pilot ranges and types

Type	Model	Operation	Range Wh		Spring Table web link
			MPa	barg	
Main pilot	201/A	Manual	0.0007 - 0.058	0.007 - 0.58	<a href="#">TT 475</a>
Main pilot	204/A	Manual	0.02 - 1.2	0.2 - 12	<a href="#">TT 433</a>

**Table 3** Settings Table

Pilot adjustment	
Pilot type .../A	Manual setting
Pilot type .../D	Electric remote setting control
Pilot type .../CS	Pneumatic remote setting control
Pilot type .../FIO	Smart unit for remote setting, monitoring, flow limitation

**Table 4** Pilot adjustment table

General link to the calibration tables: [PRESS HERE](#) or use the QR code:



The pilot system comes complete with an adjustable AR100 restrictor. The flow rate of the pilot system is controlled by the bleed rate through the AR100 restrictor which influences the response time of the regulator.

Pressure drop through the adjustable AR100 restrictor shall be about 0.02 MPa (0.2 barg) at the minimum opening flow of the regulator and about 0.1 MPa (1 barg) at the maximum opening flow of the regulator.

# Accessories

## For the pressure regulators:

- Cg limiter
- Silencer

## For the pilot circuit:

- Supplementary filter CF14 or CF14/D

## Incorporated monitor and slam shut

The unique feature of Terval series pressure regulators is to have emergency monitor and slam shut device incorporated together with the active regulator in the same body.

This provides a three functions device in a single body allowing smaller footprint for the installation.



## Monitor PM/182

**This emergency regulator (monitor) is directly integrated** onto the body of the main regulator. Both pressure regulators, therefore, use the same valve body, although they have independent actuators, pilots and valve seats.







The monitor is normally in fully open position during normal operation of the active regulator and takes over on in the event of its failure.

The operational characteristics of the PM/182 monitor are the same as for the Reval 182 regulator (refer to that specific catalogue).





The Cg coefficients of regulator having an incorporated monitor is 5% lower than those for standard version.

This solution allows the construction of reduction pressure lines with compact dimensions.

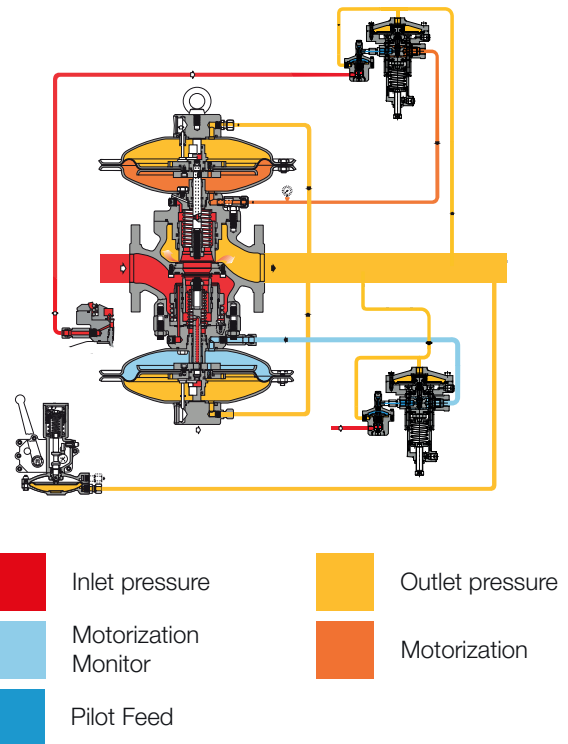
Another great advantage offered by the incorporated monitor regulator is that **it can be installed at any time**, even on an existing regulator, **without major changes to the pipework.**

-  Compact dimensions
-  Completely independent
-  "Fail to close" action
-  Built-in pilot filter
-  Visual opening indicator
-  Easy maintenance
-  Limit switch option
-  Accelerator option



	Inlet pressure		Outlet pressure
	Motorization Monitor		Motorization
	Pilot Feed		

**Figure 4** Terval/R PM/182

Type	Model	Operation	Range Wh		Spring Table web link
			MPa	barg	
Main pilot	204/A	Manual	0.03 - 4.3	0.3 - 43	<a href="#">TT 433</a>
Main pilot	205/A	Manual	2 - 6	20 - 60	<a href="#">TT 799</a>
Main pilot	206/A	Manual	3.2 - 6.5	32 - 65	<a href="#">TT 1050</a>
Main pilot	207/A	Manual	4.1 - 7.4	41 - 74	<a href="#">TT 1146</a>

**Table 5** Setting table

Types of pilot adjustment	
Pilot type .../A	Manual setting
Pilot type .../D	Electric remote setting control
Pilot type .../CS	Pneumatic remote setting control
Pilot type .../FIO	Smart unit for remote setting, monitoring, flow limitation

**Table 8** Pilot adjustment table

The monitor regulator can be equipped with an additional pilot called “accelerator” to enable a quick response time during the monitor take over. According to PED the accelerator is required on the monitor when acting as a safety accessory.

Type	Model	Operation	Range Wh		Spring Table web link
			MPa	barg	
Accelerator	V/25 BP	Manual	0.0015 – 0.02	0.015 – 0.2	<a href="#">TT 00601</a>
Accelerator	V/25 MP	Manual	0.02 – 0.06	0.2 – 0.6	<a href="#">TT 00601</a>
Accelerator	M/A	Manual	0.03 - 2	0.3 - 20	<a href="#">TT 354</a>
Accelerator	M/A1	Manual	2 - 6.3	20 - 63	<a href="#">TT 892</a>
Accelerator	M/A2	Manual	4 - 7.5	40 - 75	<a href="#">TT 892</a>

**Table 9** Accelerator adjustment table

General link to the calibration tables: [PRESS HERE](#) or use the QR code:





## Silencer DB/182

Whenever certain noise limit is desired, an additional silencer allows to considerably reduce the noise level (dBA).

The Terval/R pressure regulator can be supplied with an **incorporated silencer**.

The high efficiency rely to the fact that noise absorption takes place at the same point where the noise is generated, thus preventing its propagation.

With the built-in silencer, the Cg valve coefficient is 5% lower than the corresponding version without.

Given the modular arrangement of the regulator, the silencer may be retrofitted **without the need to modify the main piping**.

Pressure reduction and control operate the same manner as standard version.

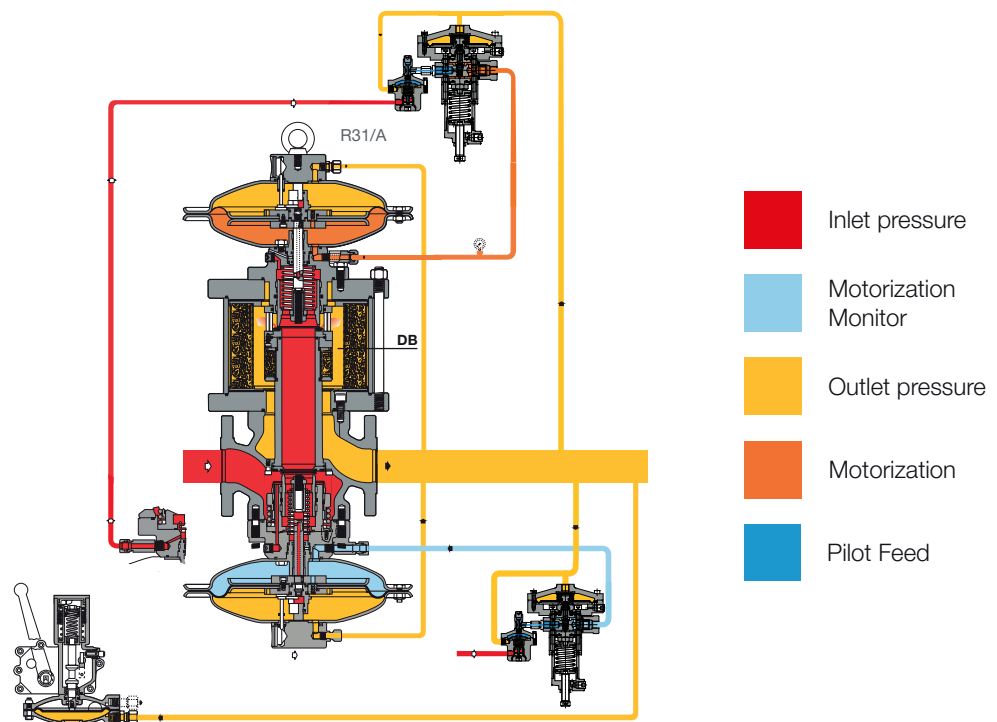

**Figure 5** Terval/R with Silencer DB/182

The chart below represents the silencer effectiveness based on some common reference conditions for 2", 3" and 4". For actual calculations at specific desired conditions please refer to the online sizing tool or contact your closest Pietro Fiorentini representative.

- Pd 0.02 MPa | 0.2 barg NO Silencer
- Pd 0.05 MPa | 0.5 barg NO SILENCER
- Pd 0.2 MPa | 2 barg NO Silencer
- ..... Recommended noise limit (85 dBA at 1 mt | 3 feet)
- Pd 0.02 MPa | 0.2 barg DB/182
- Pd 0.05 MPa | 0.5 barg DB/182
- Pd 0.2 MPa | 2 barg DB/182

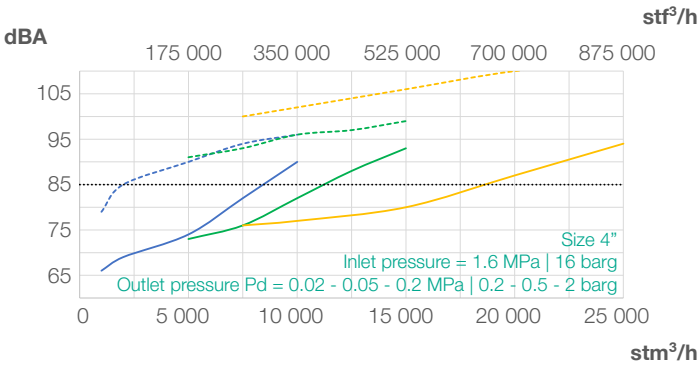
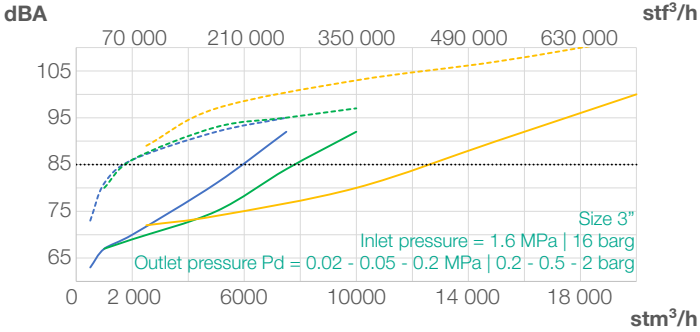
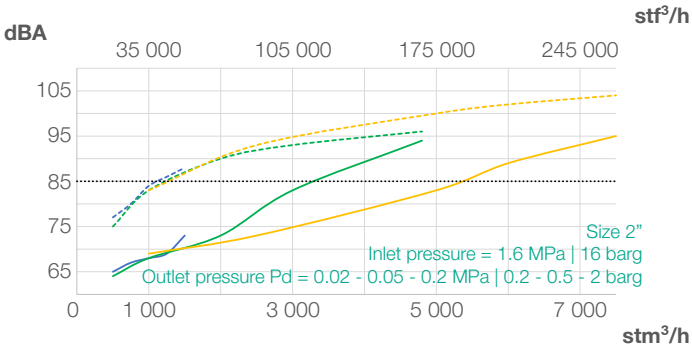
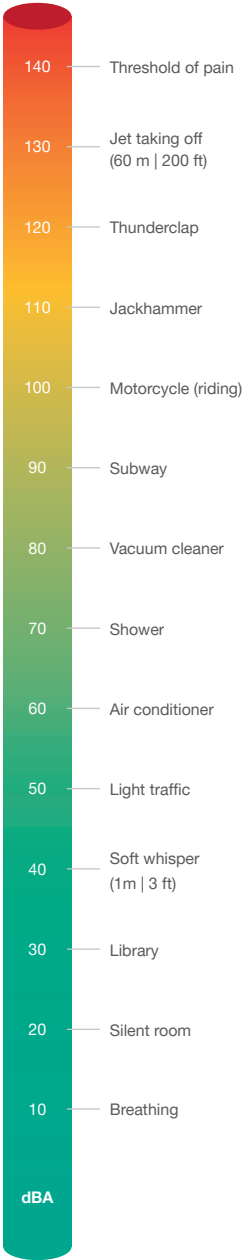

**Chart 1** Terval/R's silencer efficiency charts



## Slam shut SA









The Terval/R pressure regulator offers the possibility of installing an **incorporated slam shut valve SA** valve and this can be done either during the manufacturing process or be retrofitted in the field.

SA is available for all sizes.

**Retrofitting can be done without modifying** the pressure regulator assembly.

With the built-in slam shut, the Cg valve coefficients is 5% lower than the corresponding version without.

The main characteristics of this device are:

-  Over Pressure Shut-Off
-  Under Pressure Shut-Off
-  Internal by-pass
-  Push button for tripping test
-  Compact dimensions
-  Easy maintenance
-  Remote tripping option
-  Limit switch option

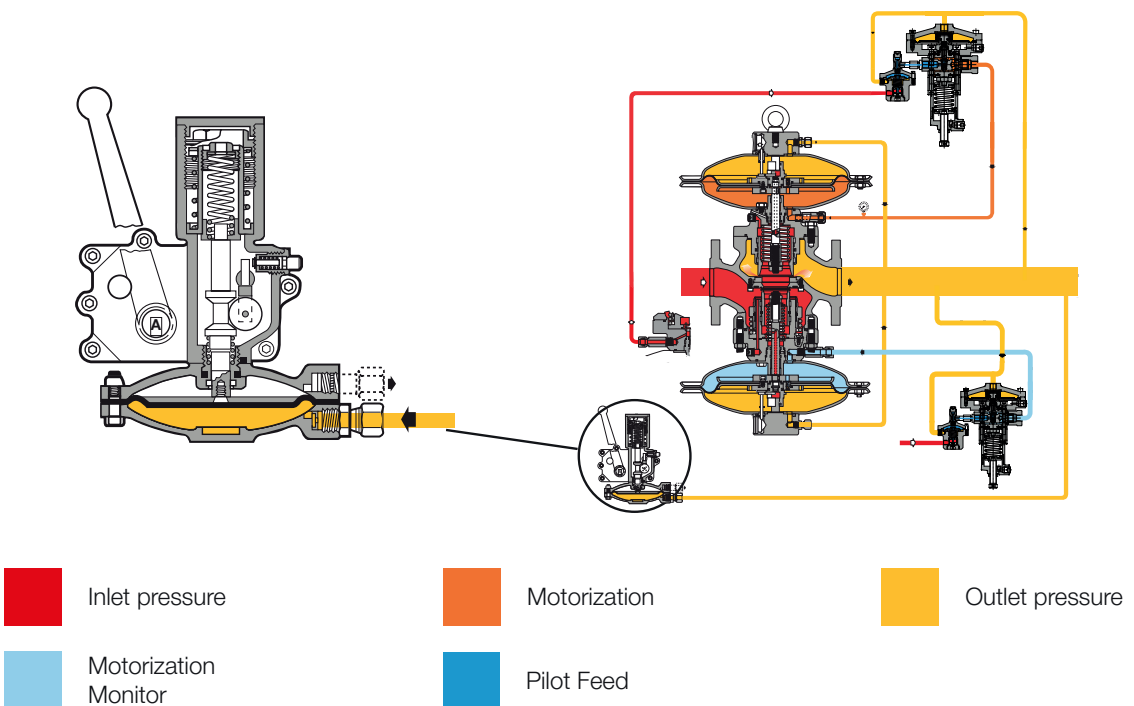

**Figure 6** Terval/R SA



Pressure switch types and ranges					
SSV Type	Model	Operation	Range Wh		Spring Table web link
			KPa	mbarg	
SA	91	OPSO	2.5 - 110	25 - 1100	<a href="#">TT 1381</a>
		UPSO	1 - 90	10 - 900	
SSV Type	Model	Operation	Range Wh		Spring Table web link
			MPa	barg	
SA	92	OPSO	0.07 - 0.5	0.7 - 5	<a href="#">TT 1381</a>
		UPSO	0.025 - 0.301	0.25 - 3.01	
SA	93	OPSO	0.3 - 1.33	3 - 13.3	<a href="#">TT 1381</a>
		UPSO	0.08 - 0.77	0.8 - 7.7	

**Table 10** Setting table



# Weights and Dimensions

## Terval/R

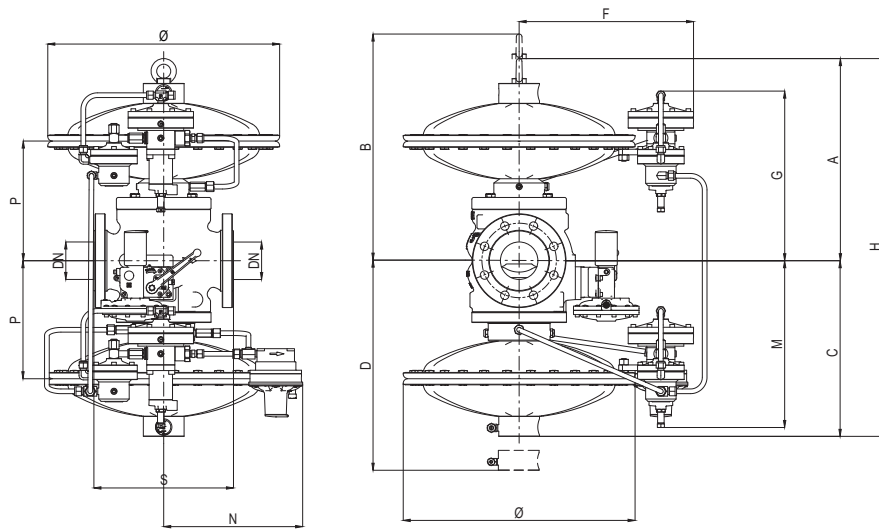

Figure 7 Terval/R dimensions

Weights and Dimensions (for other connections please contact your closest Pietro Fiorentini representative)				
	[mm]   inches	[mm]   inches	[mm]   inches	[mm]   inches
Size (DN)	50   2"	65   2" 1/2	80   3"	100   4"
S - ANSI 150/PN16	254   10"	276   10.87"	298   11.73"	352   13.86"
Ø	375   14.76"	495   19.49"	495   19.49"	495   19.49"
A	353   13.90"	426   16.77"	430   16.93"	467   18.38"
B	430   16.93"	530   20.87"	530   20.87"	600   23.62"
C	308   12.13"	373   14.68"	380   14.96"	410   16.14"
D	430   16.93"	530   20.87"	530   20.87"	600   23.62"
F	320   12.60"	385   15.16"	385   15.16"	385   15.16"
G	280   11.02"	330   12.99"	335   13.19"	367   14.45"
H	665   26.18"	800   31.50"	810   31.89"	877   34.53"
M	280   11.02"	325   12.79"	330   12.99"	360   14.17"
N	290   11.42"	298   11.73"	303   11.93"	306   12.05"
P	205   8.07"	250   9.84"	260   10.24"	290   11.42"
Tubing connections	Øe 10 x Øi 8 (on request imperial sizing)			

Weight	Kg   lbs	Kg   lbs	Kg   lbs	Kg   lbs
ANSI 150/PN 16	70   154	107   236	123   271	170   375

Table 11 Weights and dimensions

## Terval/R + DB/182

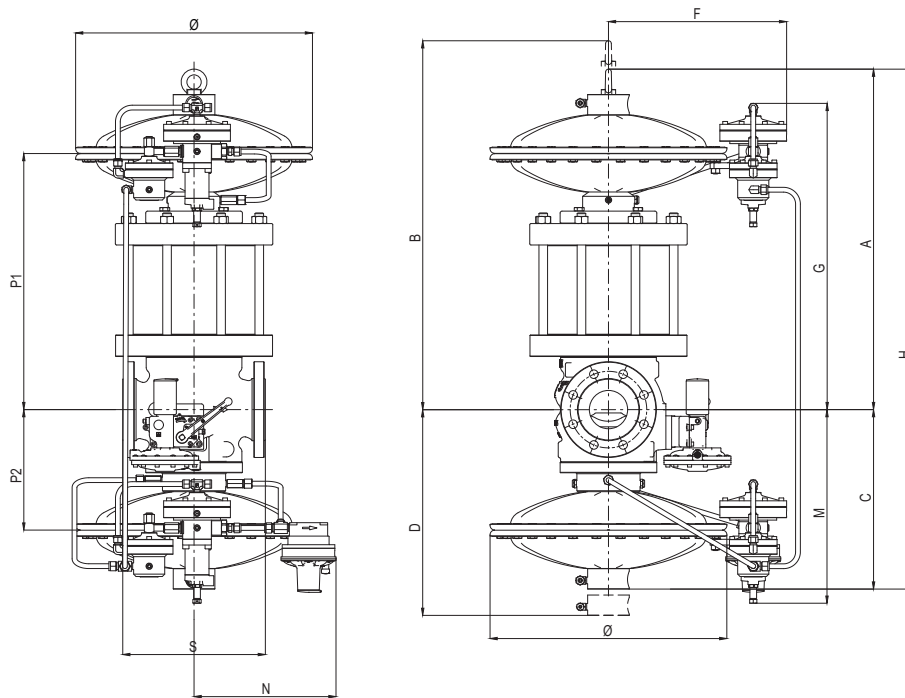

**Figure 8** Terval/R + DB/182

Weights and Dimensions (for other connections please contact your closest Pietro Fiorentini representative)				
	[mm]   inches	[mm]   inches	[mm]   inches	[mm]   inches
Size (DN)	50   2"	65   2" 1/2	80   3"	100   4"
S - ANSI 150/PN16	254   10"	276   10.87"	298   11.73"	352   13.86"
Ø	375   14.76"	495   19.49"	495   19.49"	495   19.49"
A	487   19.17"	555   21.85"	576   22.68"	678   26.69"
B	497   19.57"	565   22.24"	586   23.07"	688   27.09"
C	308   12.13"	373   14.68"	380   14.96"	410   16.14"
D	430   16.93"	530   20.87"	530   20.87"	600   23.62"
E	178   7.01"	178   7.01"	178   7.01"	178   7.01"
H	795   31.3"	913   35.94"	980   38.58"	1088   42.83"
M	320   12.60"	385   15.16"	385   15.16"	385   15.16"
N	290   11.42"	298   11.73"	303   11.93"	306   12.05"
K	400   15.7"	470   18.5"	505   19.9"	575   22.6"
Tubing connections	Øe 10 x Øi 8 (on request imperial sizing)			

Weight	Kg   lbs	Kg   lbs	Kg   lbs	Kg   lbs
ANSI 150/PN 16	94   207	124   273	152   335	210   463

**Table 12** Weights and dimensions



# Sizing and Cg

In general, the choice of a regulator is made based on the calculation of the flow rate determined by the use of formulae using the flow rate coefficients (Cg) and the form factor (K1) as indicated by the EN 334 standard.

Flow rate coefficient				
Nominal size	50	65	80	100
Inches	2"	2" 1/2	3"	4"
Cg	1706	2731	3906	5490
K1	108	104	100	100

**Table 13** Flow rate coefficient

For sizing [PRESS HERE](#) or use the QR code:



**Note:** In case you do not have the proper credentials to access, feel free to contact your closest Pietro Fiorentini representative.

In general the online sizing considers multiple variables as the regulator is installed in a system, enabling a better and multiperspective approach to the sizing.

For different gases, and for natural gas with a different relative density other than 0.61 (compared to air), the correction coefficients from the following formula shall be applied.

$$F_c = \sqrt{\frac{175,8}{S \times (273,16 + T)}}$$

S = relative density (refere to table 12)  
T = gas temperature ( °C )

### Correction Factor Fc

Gas Type	Relative Density S	Correction Factor Fc
Air	1.00	0.78
Propane	1.53	0.63
Butane	2.00	0.55
Nitrogen	0.97	0.79
Oxygen	1.14	0.73
Carbon Dioxide	1.52	0.63

Note: the table shows the Fc correction factors valid for Gas, calculated at a temperature of 15°C and at the declared relative density.

**Table 14** Correction factor Fc

### Flow rate conversion

$$\text{Stm}^3/\text{h} \times 0.94795 = \text{Nm}^3/\text{h}$$

Nm<sup>3</sup>/h reference conditions T= 0 °C; P= 1 barg  
Stm<sup>3</sup>/h reference conditions T= 15 °C; P= 1 barg

**Table 15** Flow rate conversion

### CAUTION:

In order to get optimal performance, to avoid premature erosion phenomena and to limit noise emissions, it is recommended to check that the gas speed at the outlet flange does not exceed the values of the graph below. The gas speed at the outlet flange may be calculated by means of the following formula:

$$V = 345.92 \times \frac{Q}{\text{DN}^2} \times \frac{1 - 0.002 \times \text{Pd}}{1 + \text{Pd}}$$

V = gas speed in m/s  
Q = gas flow rate in Stm<sup>3</sup>/h  
DN = nominal size of regular in mm  
Pd = outlet pressure in barg

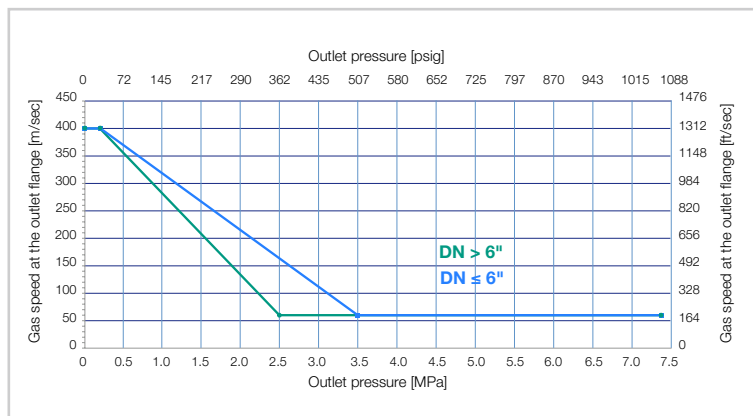



Sizing of regulators is usually made based on valve Cg value (table 11).

Flow rates at fully open position and various operating conditions are related by the following formulae where:

Q = flow rate in Stm<sup>3</sup>/h

Pu = inlet pressure in bar (abs)

Pd = outlet pressure in bar (abs).

- **A** > when the Cg value of the regulator is known, as well as Pu and Pd, the flow rate can be calculated as follows:

- **A-1** in sub critical conditions: (Pu < 2 x Pd)

$$Q = 0.526 \times C_g \times P_u \times \sin \left( K_1 \times \sqrt{\frac{P_u - P_d}{P_u}} \right)$$

- **A-2** in critical conditions: (Pu ≥ 2 x Pd)

$$Q = 0.526 \times C_g \times P_u$$

- **B** > vice versa, when the values of Pu, Pd and Q are known, the Cg value, and hence the regulator size, may be calculated using:

- **B-1** in sub-critical conditions: (Pu < 2 x Pd)

$$C_g = \frac{Q}{0.526 \times P_u \times \sin \left( K_1 \times \sqrt{\frac{P_u - P_d}{P_u}} \right)}$$

- **B-2** in critical conditions (Pu ≥ 2 x Pd)

$$C_g = \frac{Q}{0.526 \times P_u}$$

NOTE: The sin value is understood to be DEG.



**Pietro  
Fiorentini**



# Pietro Fiorentini

**TB0018ENG**



The data are not binding. We reserve the right  
to make changes without prior notice.

tervalr\_technicalbrochure\_ENG\_revC

[www.fiorentini.com](http://www.fiorentini.com)