

HM-iCON

Commercial and light industrial metering

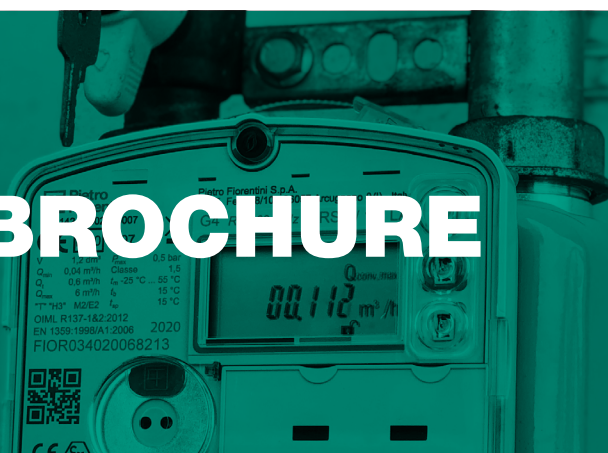

TECHNICAL BROCHURE



Pietro Fiorentini S.p.A.

Via E.Fermi, 8/10 | 36057 Arcugnano, Italy | +39 0444 968 511
sales@fiorentini.com

The data are not binding. We reserve the right
to make changes without prior notice.

hmicon_technicalbrochure_ENG_revA

www.f Fiorentini.com

Who we are

We are a global organization that specializes in designing and manufacturing technologically advanced solutions for natural gas treatment, transmission and distribution systems.

We are the ideal partner for operators in the Oil & Gas sector, with a business solutions that span the whole natural gas chain.

We are constantly evolving to meet our customers' highest expectations in terms of quality and reliability.

Our aim is to be a step ahead of the competition, with customized technologies and an after-sale service program undertaken with the highest level of professionalism.



Pietro Fiorentini advantages



Localised technical support



Experience since 1940



Operating in over 100 countries



Area of Application

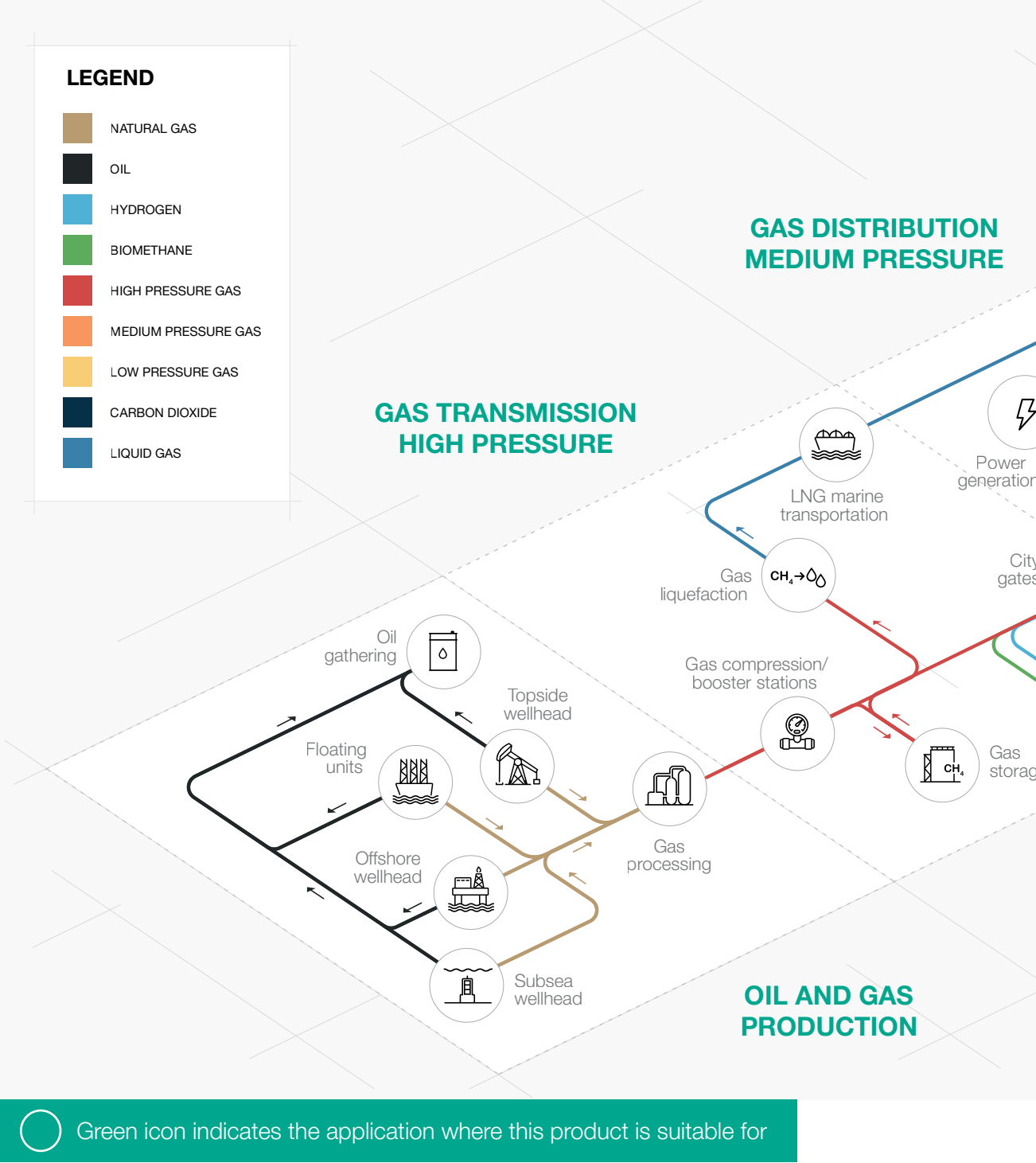

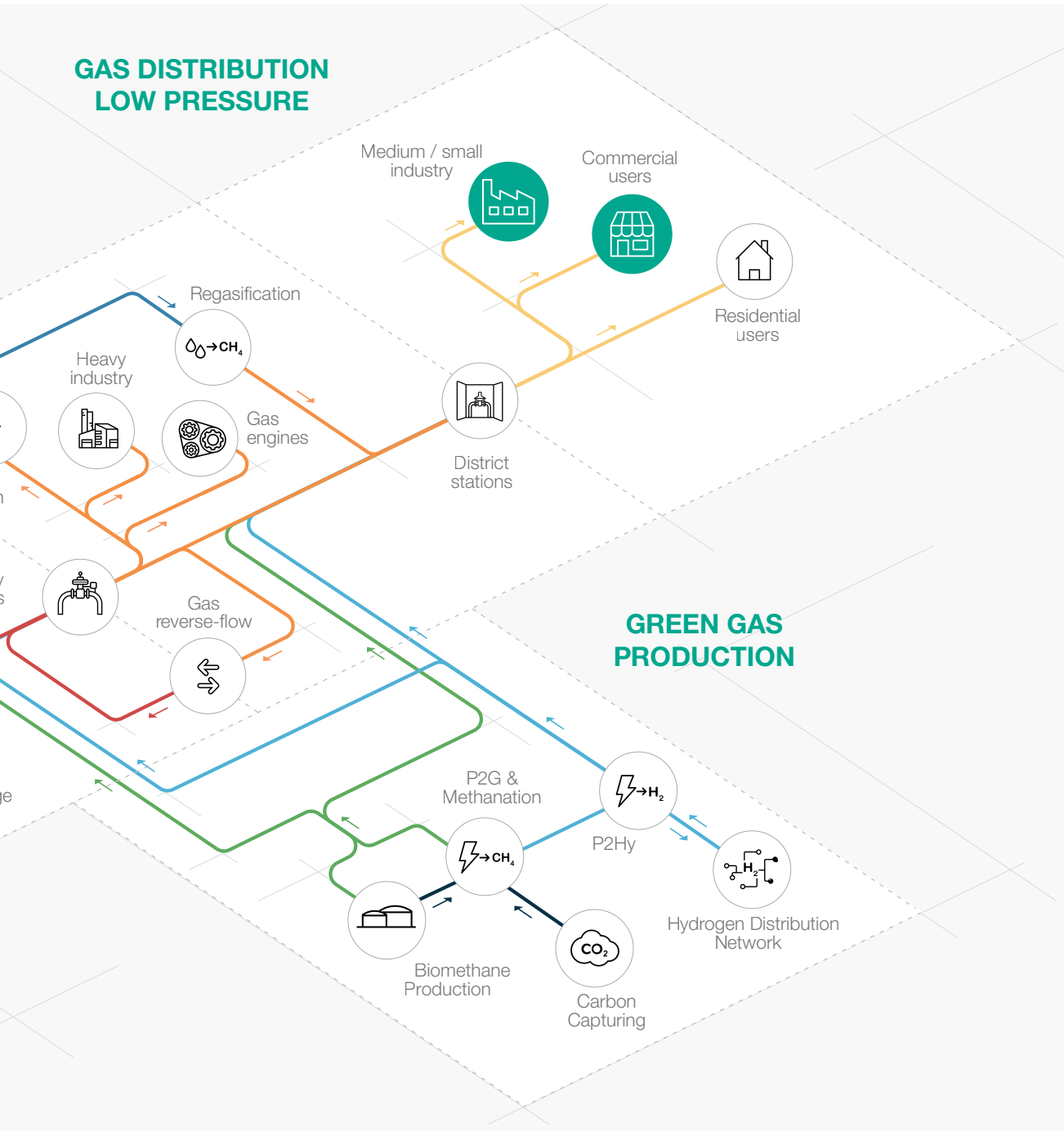

Figure 1 Area of application map



Introduction

The **HM-iCON** is a **smart meter with hybrid technology** for commercial and light-industrial applications.

The HM gas meters series are designed and manufactured to meet the most stringent requirements of the European Natural Gas Distribution industry.



Figure 2 HM-iCON

Features

The HM-iCON combines new generation electronical features with a **diaphragm measuring unit**. The mechanical register is now replaced by an **electronic totalizer** equipped with a data transmission interface and a **remote firmware update function**. The HM-iCON combines **integrated temperature and pressure sensors** that can be used (by configuration) in order to perform gas volume compensation (this feature is only configurable in factory) of the measured gas volume.

The HM-ICON series gas meters are designed and manufactured to maximize performances:

- metrological module with non replaceable battery (16 years in operation + 1 year in storage);
- GPRS or NB-IoT communication module with dedicated field replaceable battery power (up to 8 years with GPRS, up to 16 years with NB-IoT);
- user interface with LCD display and user-friendly icons;
- 3 buttons MMI (Man-Machine Interface);
- internal pressure and temperature sensor;
- a thermowell and a pressure intake valve to allow maintenance and any other check without interrupting the gas delivery to the end user.

Models

The HM- iCON series devices can be supplied in 3 configurations:

- HM-ICON-**M16** (G10);
- HM-ICON-**M25** (G16);
- HM-ICON-**M40** (G25);

with two different communication technologies NB-IoT or GPRS.

HM-ICON is a MID-approved integrated meter with internal Pressure and Temperature sensors for PT volume conversion. The display shows the volume totalizers at base conditions only (Vb).

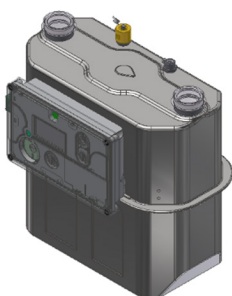

Figure 3 HM-ICON-M16

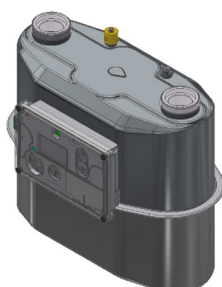

Figure 4 HM-ICON-M25

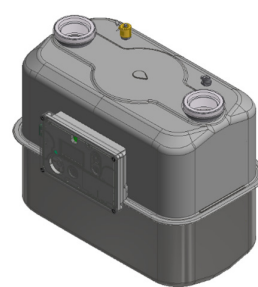

Figure 5 HM-ICON-M40



Accuracy

Below a typical accuracy performance of HM-iCON smart gas meter.

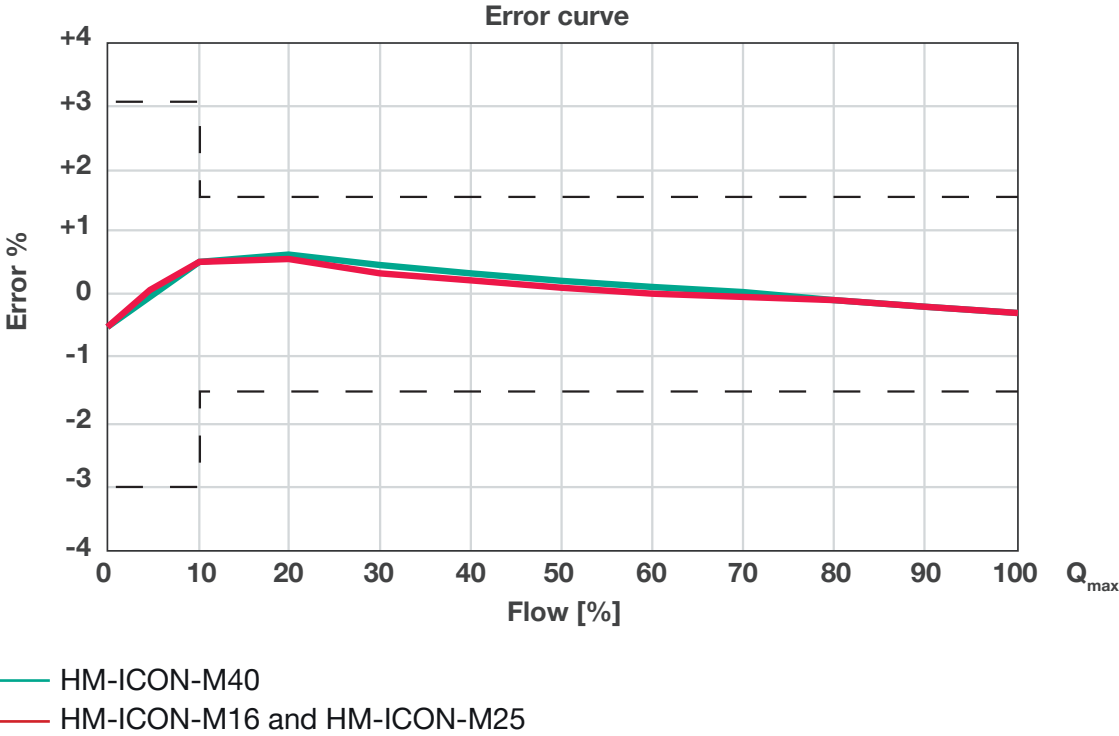

Figure 6 Error curve

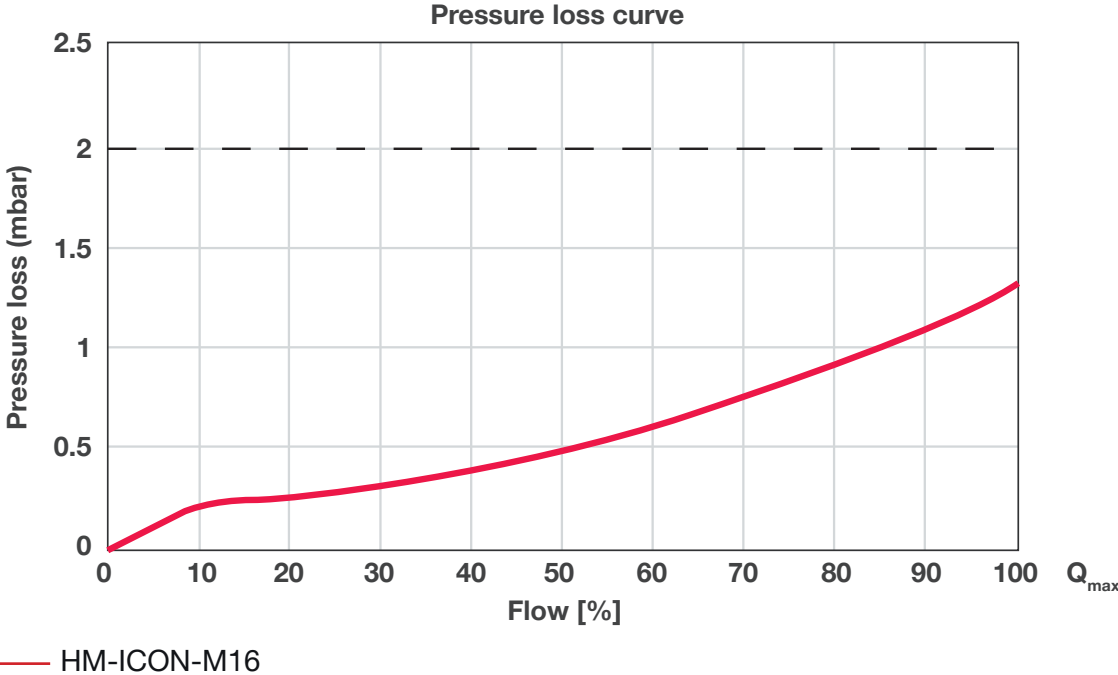

Figure 7 HM-iCON-M16 pressure loss curve

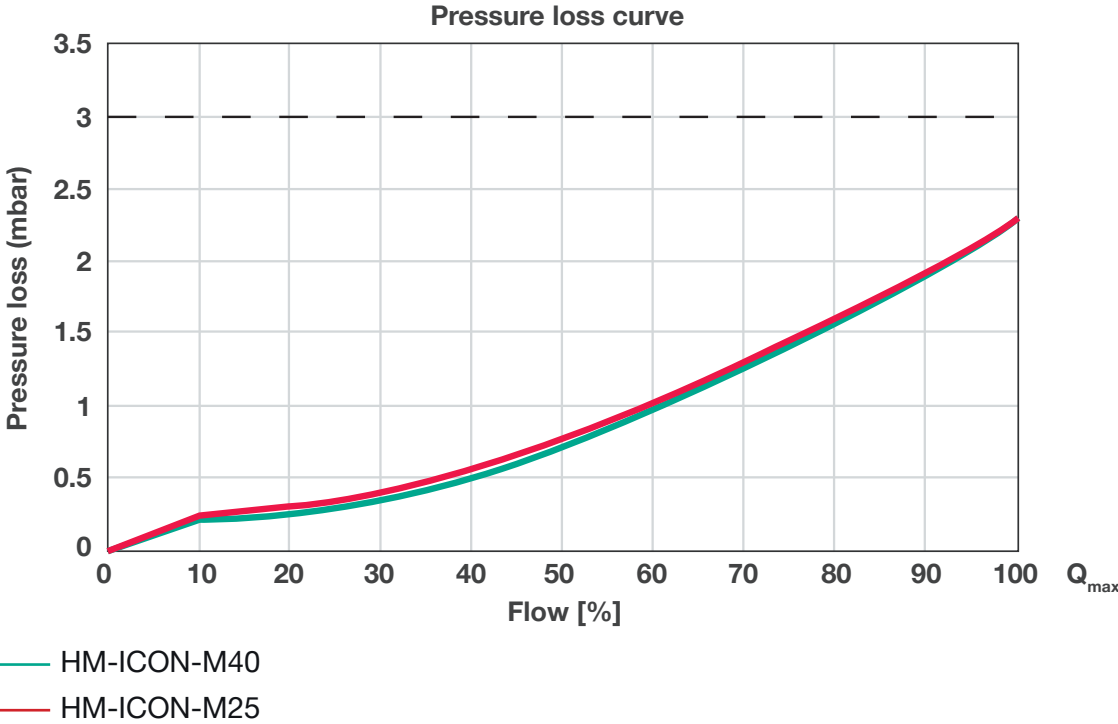

Figure 8 HM-ICON-M25 and HM-ICON-M40 pressure loss curve



Features

Features	Values		
G type	G10	G16	G25
Model	HM-ICON- M16	HM-ICON- M25	HM-ICON- M40
Minimum flow rate (Q_{min})	100 dm ³ /h 3.5 scfh	160 dm ³ /h 5.6 scfh	250 dm ³ /h 8.8 scfh
Cyclic volume	6 dm ³ 1.3 gal	6 dm ³ 1.3 gal	8 dm ³ 1.75 gal
Maximum flow rate	16 m ³ /h 560 scfh	25 m ³ /h 875 scfh	40 m ³ /h 1400 scfh
Connections (ISO 228-1)	1" ¼ 2"	2"	2" ½
Maximum permissible error range $Q_{min} \leq Q < 0.1Q_{max}$	±3%		
Maximum permissible error range $0.1Q_{min} \leq Q \leq Q_{max}$	±1.5%		
Maximum operating pressure	up to 50 kPa up to 500 mbarg		
Ambient temperature	from -25 °C to 55 °C from -13 °F to 131 °F		
Gas temperature	from -25 °C to 55 °C from -13 °F to 131 °F		
Accuracy class	1.5		
Ingress protection	IP65 or IP66		
Metrological power supply and operating lifetime	lithium battery; 16 years in operation + 1 year in storage		
Remote communication power supply and operating lifetime	lithium battery; <ul style="list-style-type: none"> • GPRS up to 8 years in operation + 1 year in storage • NB-IoT up to 16 years in operation + 1 year in storage 		
Remote communication interface	NB-IoT, GPRS		
Local interface	optical interface configuration according to EN Standard 62056-21		
Communication application protocol	DLMS standard application layer protocol		
Measuring gas	natural gas (2 nd family -group H,L and E and 3 rd family – according to EN 437		
Environment classes	M1/E2		
ATEX classification	II 2G Ex h ia IIB T3 Gb		
<p>(*) REMARK: Different functional features and/or extended temperature ranges available on request. Stated temperature ranges are the maximum for which the equipment's full performance, including accuracy, are fulfilled. Standard product may have a narrower range.</p>			

Table 1 Features

HM-iCON competitive advantages



Temperature and pressure integrated sensors



16+1 years metrological battery



Open communication protocol DLMS based



Up to 16 years communication battery life with NB-IoT



GPRS or NB-IoT communication technology



Biomethane compatible and 20% Hydrogen blending compatible. Higher blending available on request



Advanced diagnostic

Materials and Approvals

Part	Material
Body	zinc-coated pressed steel plate
Electronic enclosure	plastic polycarbonate

REMARK: The materials indicated above refer to the standard models. Different materials can be provided according to specific needs.

Table 2 Materials

The HM-iCON is designed to meet ISO 12213-3, 2014/32/UE MID, EN1359:2017, OIML R 137-1 & 2 and UNI/TS 11291.

The product is certified according to European Directives 2014/32/EU (MID).

The HM-iCON is also ATEX approved for installation in Zone 1 (II 2G Ex h ia T3 Gb)



ISO
12213-3



EN1359:2017



OIML
R137-1&2



UNI/TS
11291



MID



ATEX



RED



Weights and Dimensions

HM-iCON

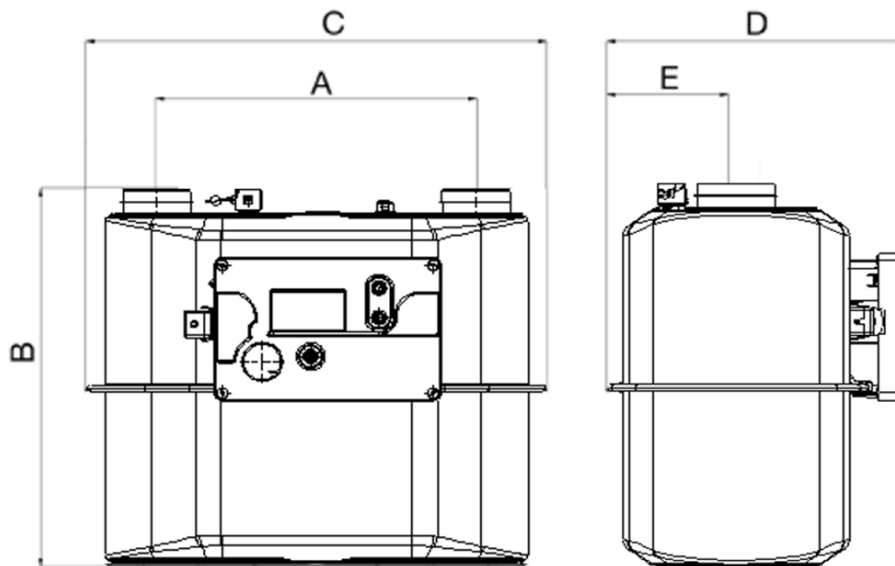

Figure 9 HM-iCON dimensions

Weights and Dimensions (for other connections please contact your closest Pietro Fiorentini representative)								
Model	HM-ICON-M16		HM-ICON-M25		HM-ICON-M40			
	[mm]	inches	[mm]	inches	[mm]	inches	[mm]	inches
A	250	9.8"	280	11.0"	280	11.0"	335	13.2"
B	310	12.2"	340	13.4"	340	13.4"	375	14.8"
C	328	12.9"	402	15.8"	402	15.8"	465	18.3"
D	205	8.1"	234	9.2"	234	9.2"	299	11.8"
E	85	3.3"	103	4.1"	103	4.1"	137	5.4"
Connections	1" 1/4		2"		2"		2"1/2	
Weight	kg	lbs	kg	lbs	kg	lbs	kg	lbs
	5.2	11.5	7.0	15.5	7.0	15.5	11.2	24.7

Table 3 Weights and dimensions

Customer Centricity

Pietro Fiorentini is one of the main Italian international companies with high focus on product and service quality.

The main strategy is to create a stable long-term oriented relationship, putting the customer's needs first. Lean management and thinking and customer centricity are used to improve and maintain the highest level of customer experience.



Support

One of Pietro Fiorentini's top priorities is to provide support to the client in all phases of project development, during installation, commissioning and operation. Pietro Fiorentini has developed a highly standardized intervention management system, which helps to facilitate the entire process and effectively archive all the interventions carried out, drawing on valuable information to improve the product and service. Many services are available remotely, avoiding long waiting times or expensive interventions.



Training

Pietro Fiorentini offers training services available for both experienced operators and new users. The training is composed of the theoretical and the practical parts, and is designed, selected and prepared according to the level of use and the customer's need.



Customer Relation Management (CRM)

The centrality of customer is one of the main missions and vision of Pietro Fiorentini. For this reason, Pietro Fiorentini has enhanced the customer relation management system. This enables to track every opportunity and request from Customer in one single point and make free the information flow.



Sustainability

Here at Pietro Fiorentini, we believe in a world capable of improvement through technologies and solutions that can shape a more sustainable future. That is why respect for people, society and the environment form the cornerstones of our strategy.



Our commitment to the world of tomorrow

While in the past we limited ourselves to providing products, systems and services for the oil & gas sector, today we want to broaden our horizons and create technologies and solutions for a digital and sustainable world, with a particular focus on renewable energy projects to help make the most of our planet's resources and create a future in which the younger generations can grow and prosper.

The time has come to put the why we operate before the what and how we do it.





Pietro Fiorentini

TB0155ENG



The data are not binding. We reserve the right
to make changes without prior notice.

hmicon_technicalbrochure_ENG_revA

www.fiorentini.com